

NETGEAR®

**N150 WiFi DSL Modem Router—Essentials Edition
Model D500**

**N300 WiFi DSL Modem Router—Essentials Edition
Model D1500**

User Manual



August 2014
202-11390-01

350 East Plumeria Drive
San Jose, CA 95134
USA

Support

Thank you for selecting NETGEAR products.

After installing your device, locate the serial number on the label of your product and use it to register your product at <https://my.netgear.com>. You must register your product before you can use NETGEAR telephone support. NETGEAR recommends registering your product through the NETGEAR website. For product updates and web support, visit <http://support.netgear.com>.

Phone (US & Canada only): 1-888-NETGEAR.

Phone (Other Countries): Check the list of phone numbers at <http://support.netgear.com/general/contact/default.aspx>.

Contact your Internet service provider for technical support.

Compliance

For regulatory compliance information, visit <http://www.netgear.com/about/regulatory>.

See the regulatory compliance document before connecting the power supply.

Trademarks

NETGEAR, the NETGEAR logo, and Connect with Innovation are trademarks and/or registered trademarks of NETGEAR, Inc. and/or its subsidiaries in the United States and/or other countries. Information is subject to change without notice.

© NETGEAR, Inc. All rights reserved.

Contents

Chapter 1 Hardware Overview of the Modem Router

Unpack Your Modem Router	7
Top Panel with LEDs	8
Back Panel with Ports, DC Connector, On/Off Button, and Antennas	9
Bottom Panel Product Label	10

Chapter 2 Install and Access the Modem Router and Its Network

Position Your Modem Router	12
Before You Connect to the Modem Router	13
Wired Connection	13
WiFi Connection	13
Types of Logins	13
NETGEAR genie Automatic Setup Utility and Setup Wizard	14
Set Up Your Modem Router for DSL Service	15
DSL Service	15
Cable the Modem Router for DSL Service and Access the Modem Router ..	16
Set Up Your Modem Router for Cable or Fiber Service	18
Cable the Modem Router for Cable or Fiber Service and	
Access the Modem Router	19
Log In to the Modem Router After Setup to View or Change Settings	23
Change the Language	24
Change the admin Password and Automatic Login Time-Out	24

Chapter 3 Manage the Internet Settings Manually

Use the Internet Setup Wizard After Initial Setup	27
Manually Set Up the Internet Connection	29
Specify an Internet Connection Without a Login	29
Specify an Internet Connection That Uses a Login and PPPoE Service ...	31
Specify an Internet Connection That Uses a Login and PPPoA Service ...	34
Specify an IPv6 Internet Connection	36
IPv6 Internet Connections and IPv6 Addresses	36
Set Up an IPv6 6to4 Tunnel Connection	37
Set Up an IPv6 Pass-Through Connection	39
Set Up an IPv6 Fixed Connection	39
Set Up an IPv6 DHCP Connection	41
Set Up an IPv6 PPPoE Connection	43
Manage the MTU Size	45
MTU Concepts	45
Change the MTU Size	46

Chapter 4 Manage the WiFi Network Settings

Manage the Basic WiFi Settings and WiFi Security	49
Configure WPA/WPA2 Enterprise WiFi Security	53
Configure WEP Legacy WiFi Security	54
Manage the WiFi Radio	56
Manage Advanced WiFi Features	58
Set Up the Modem Router as a Wireless Repeater	59

Chapter 5 Manage the WAN and LAN Network Settings

Manage the ADSL Settings	63
Change the WAN Connection Preference and Second Ethernet Port	64
Manage the WAN Security Settings	66
Manage IGMP Proxying and VPN Pass-Through	67
Manage NAT Filtering	68
Manage the Application Level Gateway	70
Manage the Modem Router's LAN IP Address	71
Change the Modem Router's Device Name	72
Manage the DHCP Server Address Pool	73
Disable the Built-In DHCP Server	74
Set Up and Manage Static Routes	75
Set Up a Static Route	76
Change a Static Route	78
Remove a Static Route	78
Manage Universal Plug and Play	79

Chapter 6 Manage the Modem Router and Monitor the Traffic

Update the Firmware of the Modem Router	82
Automatically Check for New Firmware and Update the Modem Router	82
Manually Check for New Firmware and Update the Modem Router	83
Manage the Configuration File of the Modem Router	85
Back Up the Settings	85
Restore the Settings	86
Return the Modem Router to Its Factory Default Settings	87
Use the Reset Button	87
Erase the Settings	88
View the Status and Statistics of the Modem Router	89
View Information About the Modem Router and the Internet, Modem, and WiFi Settings	89
View the Traffic Statistics	92
View or Change a PPPoE or PPPoA Internet Connection	94
View or Change a TCP/IP Internet Connection	95
View the xDSL Line Status and Modem Statistics	96
View Devices Currently on the Network	98

Chapter 7 Troubleshooting

Quick Tips for Troubleshooting	101
Troubleshoot with the LEDs	102
Power LED Is Off	102
WiFi LED Is Off	102
LAN LED Is Off	103
You Cannot Log In to the Modem Router	103
Troubleshoot the Internet Connection	104
Troubleshoot the DSL Link	104
Internet LED Is Off	105
Obtain an Internet IP Address	105
Troubleshoot PPPoE or PPPoA	106
Troubleshoot Internet Browsing	107
Changes Are Not Saved	108
Troubleshoot the WiFi Connectivity	108
Troubleshoot Your Network Using the Ping Utility	109
Test the LAN Path to Your Modem Router	109
Test the Path from Your Computer to a Remote Device	110

Appendix A Supplemental Information

Factory Settings	112
Technical and Environmental Specifications	113

Hardware Overview of the Modem Router

1

This manual describes the following models:

- NETGEAR® N150 WiFi DSL Modem Router—Essentials Edition, Model D500. Provides a single antenna with WiFi connection speeds up to¹ 150 Mbps.
- NETGEAR® N300 WiFi DSL Modem Router—Essentials Edition, Model D1500. Provides two antennas with WiFi connection speeds up to¹ 300 Mbps.

In this manual, both models are referred to as the modem router.

The chapter contains the following sections:

- *Unpack Your Modem Router*
- *Top Panel with LEDs*
- *Back Panel with Ports, DC Connector, On/Off Button, and Antennas*
- *Bottom Panel Product Label*

Note: For more information about the topics that are covered in this manual, visit the support website at support.netgear.com.

Note: Firmware updates with new features and bug fixes are made available from time to time at downloadcenter.netgear.com. You can check for and download new firmware manually. If the features or behavior of your product does not match what is described in this guide, you might need to update your firmware.

Note: In this manual, the terms *wireless* and *WiFi* are interchangeable.

1. Actual data throughput and WiFi coverage will vary. Network conditions and environmental factors, including volume of network traffic, building materials and construction, and network overhead, lower actual data throughput rate and WiFi coverage. NETGEAR makes no express or implied representations or warranties about this product's compatibility with any future standards.

Unpack Your Modem Router

Your package contains the following items.

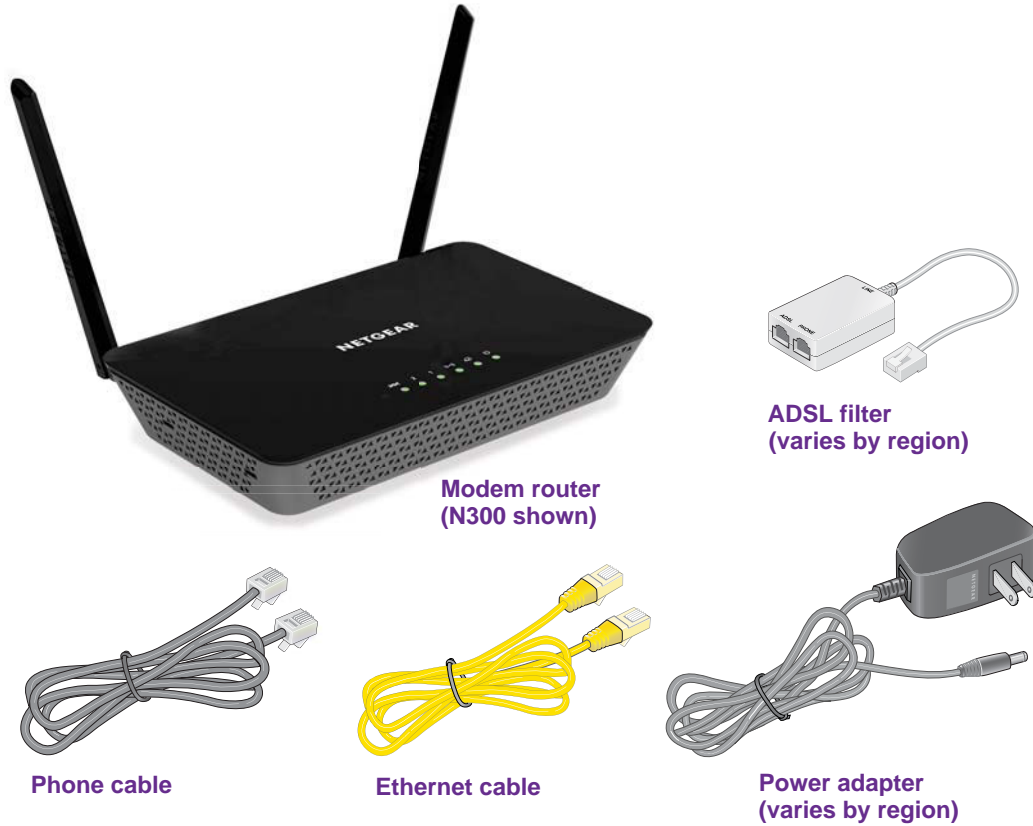

Figure 1. Package contents for the modem router

Your package might contain more items. The filter or phone cable provided depends on the region, and in some locations, a CD is included.

Top Panel with LEDs

The modem router displays status LEDs on top.

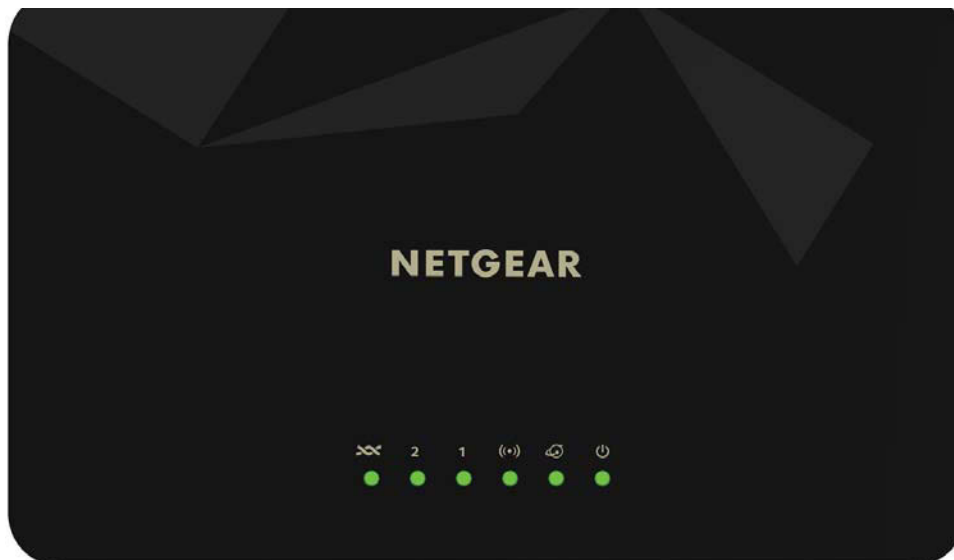







Figure 2. Modem router top view

The following table describes the LEDs from right to left.

Table 1. LED descriptions

LED	Icon	Description
Power		<ul style="list-style-type: none"> • Solid green. The power is on and the modem router is functioning normally. • Off. The modem router is not receiving power.
Internet		<ul style="list-style-type: none"> • Solid green. The modem router is connected to the Internet. • Blinking green. The Internet port is transmitting or receiving traffic. • Off. The modem router is not connected to the Internet.
WiFi		<ul style="list-style-type: none"> • Solid green. The modem router is providing WiFi connectivity. • Blinking green. The WiFi link is transmitting or receiving traffic. • Off. The modem router is not providing WiFi connectivity. You can still plug an Ethernet cable into one of the LAN ports to get wired connectivity.
Ethernet ports 1–2		<ul style="list-style-type: none"> • Solid. The Ethernet port is connected to a powered-on device. • Blinking. The Ethernet port is transmitting or receiving traffic. • Off. The Ethernet port is not connected to a powered-on device.
DSL		<ul style="list-style-type: none"> • Solid green. The modem router is providing a DSL connection. In technical terms, the DSL port is synchronized with an ISP's network-access device. • Blinking green. The modem router is negotiating the best possible speed on the DSL line. • Off. The modem router is not negotiating the speed on the DSL line and is not providing a DSL connection.

Back Panel with Ports, DC Connector, On/Off Button, and Antennas

The following figure shows the ports, connection, and buttons on the back panel of the modem router.

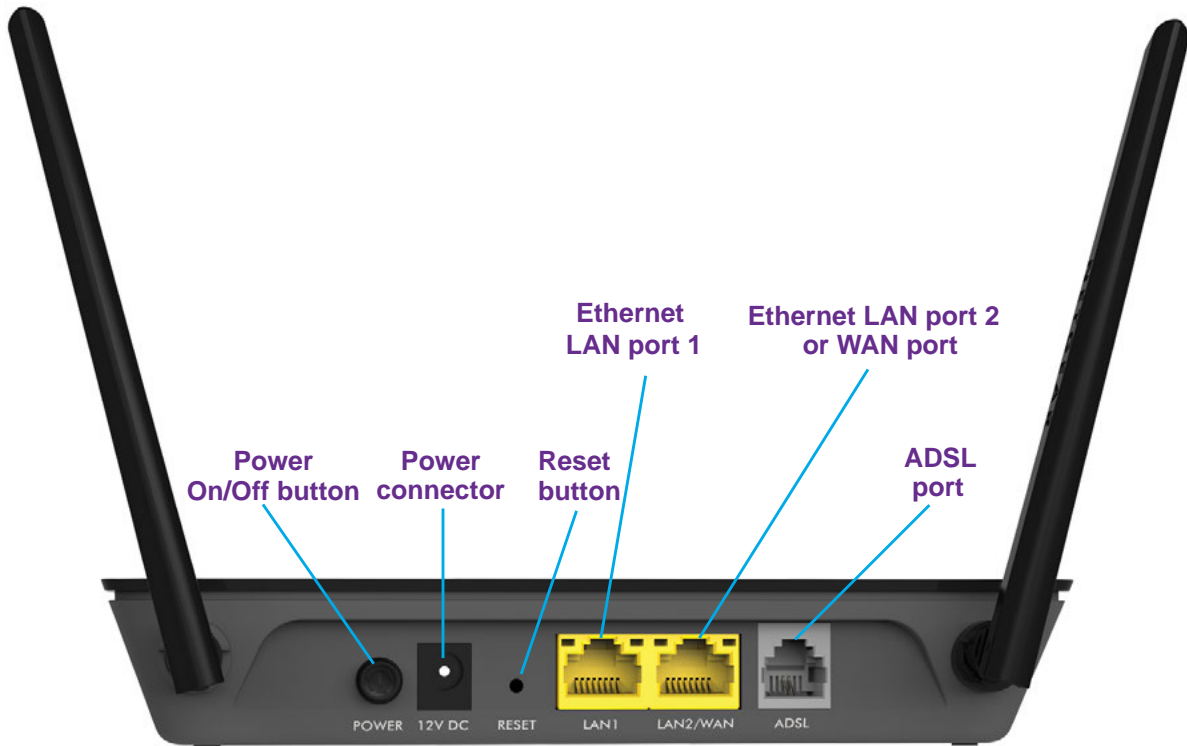

Figure 3. Modem router back panel (N300 shown)

Although you can swivel the antennas of the N300 WiFi DSL Modem Router Model D1500 in any direction, for best performance, NETGEAR recommends that you position the antennas perpendicular, that is, at a 90-degree angle to each other.



Figure 4. Recommended antenna angle

Bottom Panel Product Label

The product label on the bottom panel of the modem router lists the WiFi login information, serial number, and MAC address of the modem router.

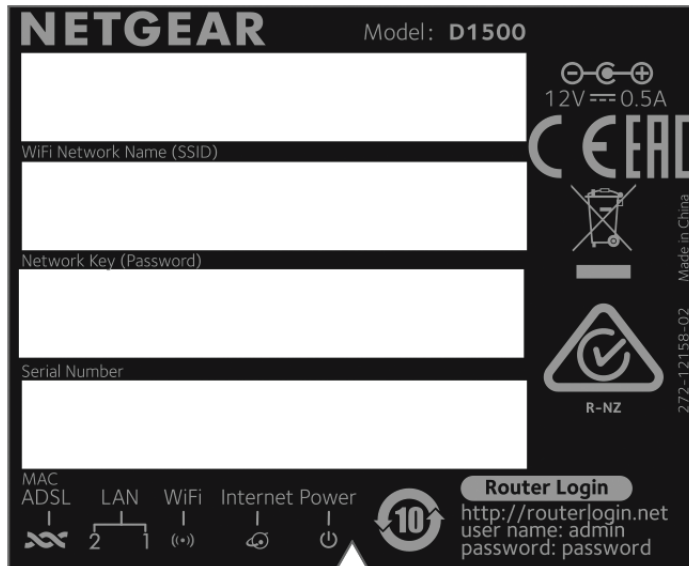

Figure 5. Modem router product label

2

2. Install and Access the Modem Router and Its Network

This chapter describes how you can install and access the modem router and its network.

The chapter contains the following sections:

- *Position Your Modem Router*
- *Before You Connect to the Modem Router*
- *Set Up Your Modem Router for DSL Service*
- *Set Up Your Modem Router for Cable or Fiber Service*
- *Log In to the Modem Router After Setup to View or Change Settings*
- *Change the Language*
- *Change the admin Password and Automatic Login Time-Out*

Position Your Modem Router

The modem router lets you access your network anywhere within the operating range of your WiFi network. However, the operating distance or range of your WiFi connection can vary significantly depending on the physical placement of your modem router. For example, the thickness and number of walls the WiFi signal passes through can limit the range.

Additionally, other WiFi access points in and around your home might affect your modem router's signal. WiFi access points are routers, repeaters, WiFi range extenders, and any other device that emits a WiFi signal for network access.

Position your modem router according to the following guidelines:

- Place your modem router near the center of the area where your computers and other devices operate and within line of sight to your WiFi devices.
- Make sure that the modem router is within reach of an AC power outlet and near Ethernet cables for wired computers.
- Place the modem router in an elevated location, minimizing the number walls and ceilings between the modem router and your other devices.
- Place the modem router away from electrical devices such as these:
 - Ceiling fans
 - Home security systems
 - Microwaves
 - Computers
 - Base of a cordless phone
 - 2.4 GHz cordless phone
- Place the modem router away from large metal surfaces, large glass surfaces, insulated walls, and items such as these:
 - Solid metal door
 - Aluminum studs
 - Fish tanks
 - Mirrors
 - Brick
 - Concrete

If you are using adjacent access points, use different radio frequency channels to reduce interference.

Before You Connect to the Modem Router

During and after installation, you can connect to the modem router's network through a wired or WiFi connection. If you set up your computer to use a static IP address, change the settings of your computer so that it uses Dynamic Host Configuration Protocol (DHCP).

Wired Connection

You can connect your computer to the modem router using an Ethernet cable and join the modem router's local area network (LAN).

WiFi Connection

You can connect to the modem router's WiFi network, which is listed on the product label in the WiFi Network Name (SSID) field. The password that you must use to connect to the WiFi network is listed in the Network Key (Password) field.

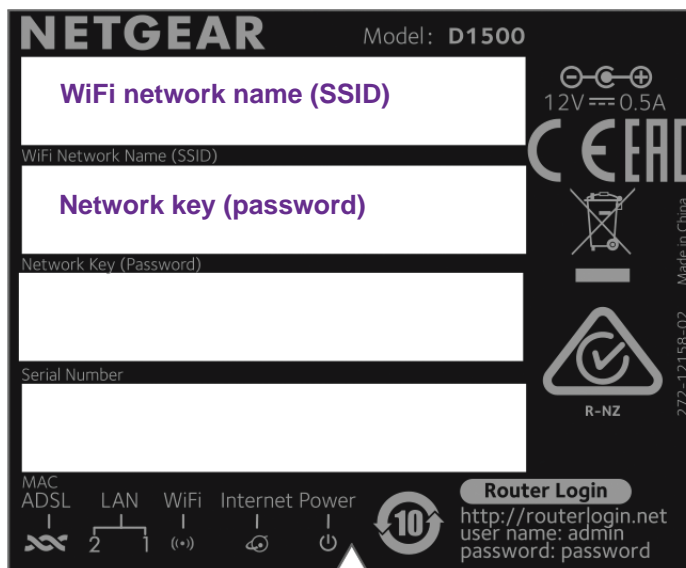

Figure 6. Modem router product label with WiFi network name (SSID) and password (network key)

Types of Logins

Separate types of logins serve different purposes. It is important that you understand the difference so that you know which login to use when.

Types of logins:

- **ISP login.** The login that your Internet service provider (ISP) gave you logs you in to your Internet service. Your ISP gave you this login information in a letter or some other way. If you cannot find this login information, contact your ISP.

- **WiFi network key or password.** Your modem router is preset with a unique WiFi network name (SSID) and password for WiFi access. This information is on the product label. Use this information to connect a WiFi device to the WiFi network of the modem router.
- **Modem Router login.** This logs you in to the modem router interface as admin from an Internet browser.

NETGEAR genie Automatic Setup Utility and Setup Wizard

The utilities that you can use during installation and setup of your modem router depend on the type of Internet service that you use:

- **DSL service.** If you install your modem router for DSL service, you can set up your modem router with the NETGEAR genie automatic setup utility, which launches the first time that you set up the Internet connection for your modem router. The NETGEAR genie automatic setup utility runs on any device with a web browser.

For more information, see [Set Up Your Modem Router for DSL Service](#) on page 15.

- **Cable or fiber service.** If you install your modem router for cable or fiber service, you cannot use the NETGEAR genie automatic setup utility. Instead, you must use the NETGEAR genie Setup Wizard.

For more information, see [Set Up Your Modem Router for Cable or Fiber Service](#) on page 18.

Note: After installation and setup, the NETGEAR genie Setup Wizard is always accessible, either for an installation with cable or fiber service or for an installation with DSL service.

Whether you install your modem router for DSL service or for cable or fiber service, you can always use the genie menus and screens to set up your modem router manually.

Before you start the setup process, get your ISP information and make sure that the settings that are described here are specified for the computers and devices in the network.

When your Internet service starts, your Internet service provider (ISP) typically gives you all the information that you need to connect to the Internet. For DSL service, you might need the following information to set up your modem router:

- The ISP configuration information for your DSL account
- ISP login name and password
- Fixed or static IP address settings (special deployment by ISP; this setting is rare)

If you cannot locate this information, ask your ISP to provide it. When your Internet connection is working, you no longer need to launch the ISP login program on your computer to access the Internet. When you start an Internet application, your modem router automatically logs you in.

Set Up Your Modem Router for DSL Service

You can install your modem router for DSL service or for cable or fiber (Ethernet WAN) service. If you use a DSL modem, follow the procedure that is described in *Cable the Modem Router for DSL Service and Access the Modem Router* on page 16. If you use a cable or fiber modem, follow the procedure that is described in *Set Up Your Modem Router for Cable or Fiber Service* on page 18.

DSL Service

Make sure that your DSL service is active before you install the modem router. You need the following information to install your DSL modem and connect to the Internet:

- **DSL user name and password.** This information is included in the welcome letter your DSL ISP sent you when you signed up for your service. Record your DSL Internet service account user name and password.
- **Your telephone number or DSL account number.** If you do not use voice service, you can use your DSL account number in place of a phone number.

If you do not know or cannot locate your DSL user name and password, call your DSL Internet service provider (ISP). Be specific when speaking with your DSL Internet service provider. For example, you could say, "I need my DSL service user name and password. Can you help me?"

Note: If your provider says that they do not support NETGEAR services, tell them that you need only your DSL user name and password; you do not need support.

Cable the Modem Router for DSL Service and Access the Modem Router

The following figure shows the cabling of your modem router for DSL service.

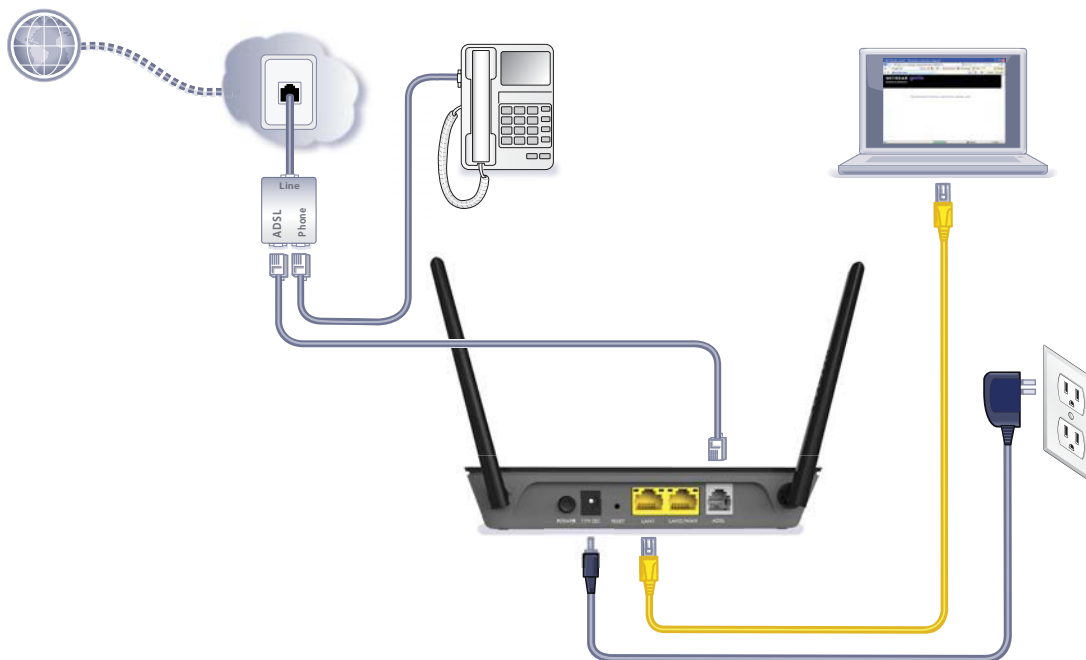



Figure 7. Modem router cabling for DSL service

➤ To connect your modem router to a DSL service:

1. Unplug your DSL modem's power, leaving the DSL modem connected to the wall jack for your Internet service.
2. If your DSL modem includes a battery backup, remove the battery.
3. Install an ADSL microfilter between the phone line and the phone.
The product package contains an ADSL microfilter.
4. Use a phone cable to connect the microfilter to the gray ADSL port on the modem router.
The product package contains a phone cable.
5. Plug in and turn on your DSL modem.
6. If your DSL modem includes a battery backup, reinsert the battery.
7. Connect the power adapter to the modem router and plug it into an electrical outlet.
Wait for the Power LED  to light solid green, which takes about 17 seconds.
8. If the Power LED does not light, press the **Power On/Off** button.

9. Connect a computer to the modem router by one of the following methods:

- **Ethernet cable.** Use an Ethernet cable to connect your computer to a yellow Ethernet port on the modem router.

The product package contains a yellow Ethernet cable.

Your computer connects to the modem router's LAN.

- **WiFi.** Connect to the default WiFi network of the modem router:

- a. On your computer or WiFi device, find and select the WiFi network.

The WiFi network name (SSID) is on the product label.

- b. Join the WiFi network and enter the WiFi password.

The password (network key) is on the product label.

Your computer or WiFi device connects to the modem router's WiFi network.

10. Launch a web browser.

The NETGEAR genie automatic setup utility displays.

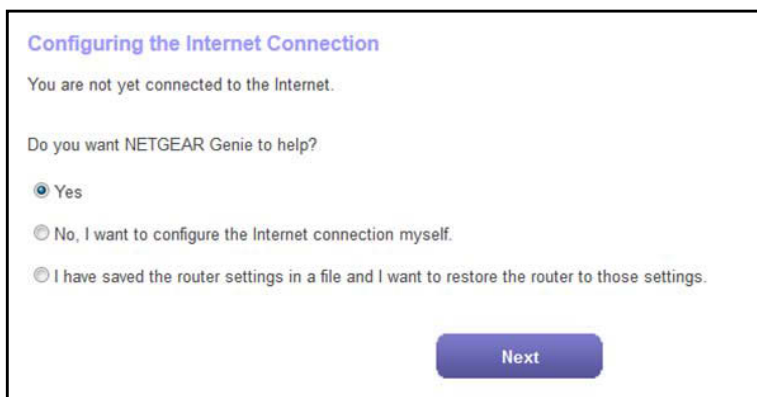

If the NETGEAR genie automatic setup utility displays, skip to [Step 12](#). If it does not display, do the following:

- a. In the address field of the web browser, enter **www.routerlogin.net**.
- b. When prompted, enter **admin** for the user name and **password** for the password.

If the NETGEAR genie automatic setup utility displays, skip to [Step 12](#). If the NETGEAR genie automatic setup utility still does not display, see [Step 11](#).

11. If the browser cannot display the web page, do the following:

- Make sure that the computer is connected to one of the two LAN Ethernet ports or over WiFi to the modem router.
- Make sure that the Power LED of the modem router is lit green.
- Make sure that your browser does not cache the previous page by closing and reopening the browser.

- Clear the browser cache.
- If the computer is set to a static or fixed IP address (this setting is uncommon), change it to obtain an IP address automatically from the modem router.

12. Follow the onscreen instructions.

The NETGEAR genie automatic setup utility guides you through connecting the modem router to the Internet.

When you are connected to the Internet, the NETGEAR genie BASIC Home screen displays. If this screen does not display, see [Step 13](#).

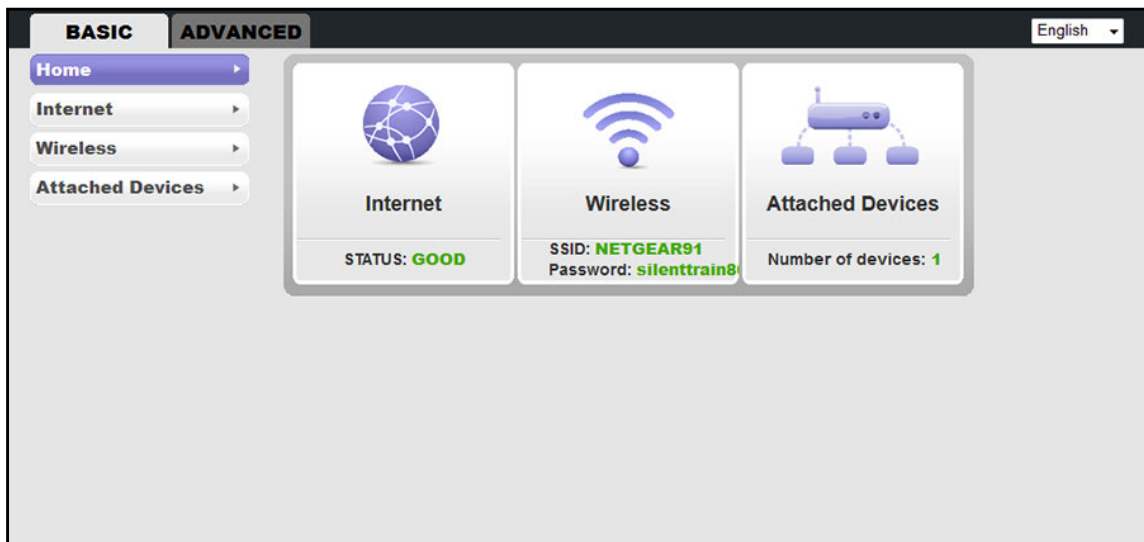

- 13.** If the modem router does not connect to the Internet, do the following:
- a. Review your settings. Make sure that you selected the correct options and typed everything correctly.
 - b. Contact your ISP to verify that you are using the correct configuration information.
 - c. Read [Troubleshoot the Internet Connection](#) on page 104. If problems persist, register your NETGEAR product and contact NETGEAR technical support.

Set Up Your Modem Router for Cable or Fiber Service

You can install you modem router for cable or fiber (Ethernet WAN) service or for DSL service. If you use a cable or fiber modem, follow the procedure that is described in [Cable the Modem Router for Cable or Fiber Service and Access the Modem Router](#) on page 19. If you use a DSL modem, follow the procedure that is described in [Set Up Your Modem Router for DSL Service](#) on page 15.

Cable the Modem Router for Cable or Fiber Service and Access the Modem Router

The following figure shows the cabling of your modem router for cable or fiber service.

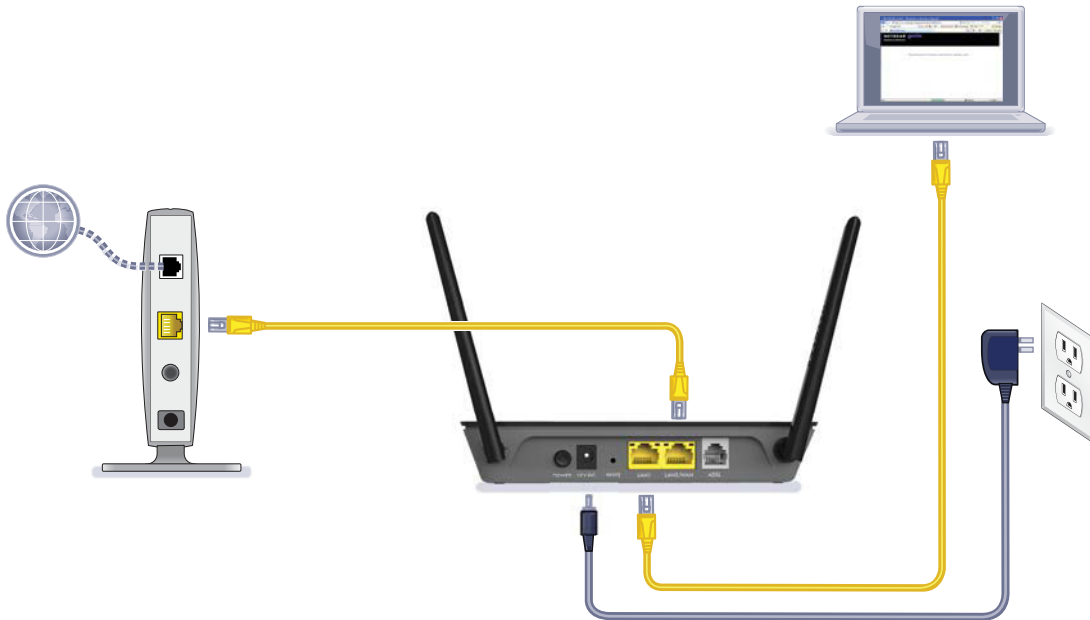



Figure 8. Modem router cabling for cable or fiber service

➤ To connect your modem router to a cable or fiber service:

1. Unplug your cable or fiber modem's power, leaving the modem connected to the wall jack for your Internet service.
2. If your cable or fiber modem includes a battery backup, remove the battery.
3. Use an Ethernet cable to connect the cable or fiber modem to the yellow LAN2/WAN Ethernet port on the modem router.

The product package contains a yellow Ethernet cable.

4. Plug in and turn on your cable or fiber modem.
5. If your cable or fiber modem includes a battery backup, reinsert the battery.
6. Connect the power adapter to the modem router and plug it into an electrical outlet.

Wait for the Power LED  to light solid green, which takes about 17 seconds.

7. If the Power LED does not light, press the **Power On/Off** button.
8. Connect a computer to the modem router by one of the following methods:
 - **Ethernet cable.** Use an Ethernet cable to connect your computer to a yellow Ethernet port on the modem router.

The product package contains a yellow Ethernet cable.

Your computer connects to the modem router's LAN.

- **WiFi.** Connect to the default WiFi network of the modem router:
 - a. On your computer or WiFi device, find and select the WiFi network.
The WiFi network name (SSID) is on the product label.
 - b. Join the WiFi network and enter the WiFi password.
The password (network key) is on the product label.Your computer or WiFi device connects to the modem router's WiFi network.

9. Launch a web browser.

The NETGEAR genie automatic setup utility displays.

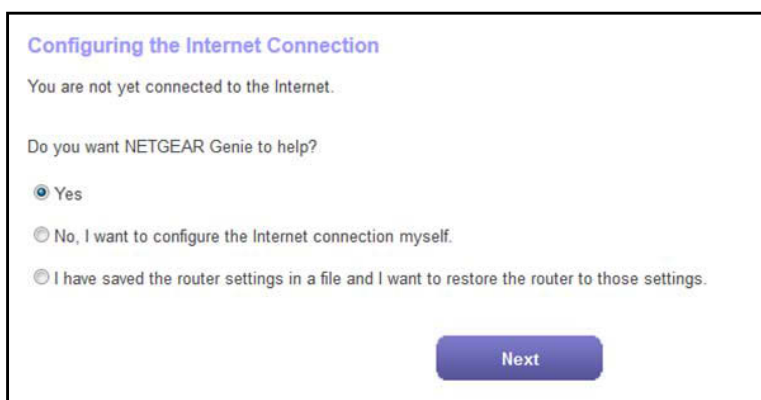

If the NETGEAR genie automatic setup utility displays, skip to [Step 11](#). If it does not display, do the following:

- a. In the address field of the web browser, enter **www.routerlogin.net**.
- b. When prompted, enter **admin** for the user name and **password** for the password.

If the NETGEAR genie automatic setup utility displays, skip to [Step 11](#). If the NETGEAR genie automatic setup utility still does not display, see [Step 10](#).

10. If the browser cannot display the web page, do the following:
 - Make sure that the computer is connected to one of the two Ethernet ports or over WiFi to the modem router.
 - Make sure that the Power LED of the modem router is lit green.
 - Make sure that your browser does not cache the previous page by closing and reopening the browser.
 - Clear the browser cache.
 - If the computer is set to a static or fixed IP address (this setting is uncommon), change it to obtain an IP address automatically from the modem router.
11. On the NETGEAR genie automatic setup utility screen, select the **No, I want to configure the Internet connection myself** radio button.

The NETGEAR genie BASIC home screen displays.

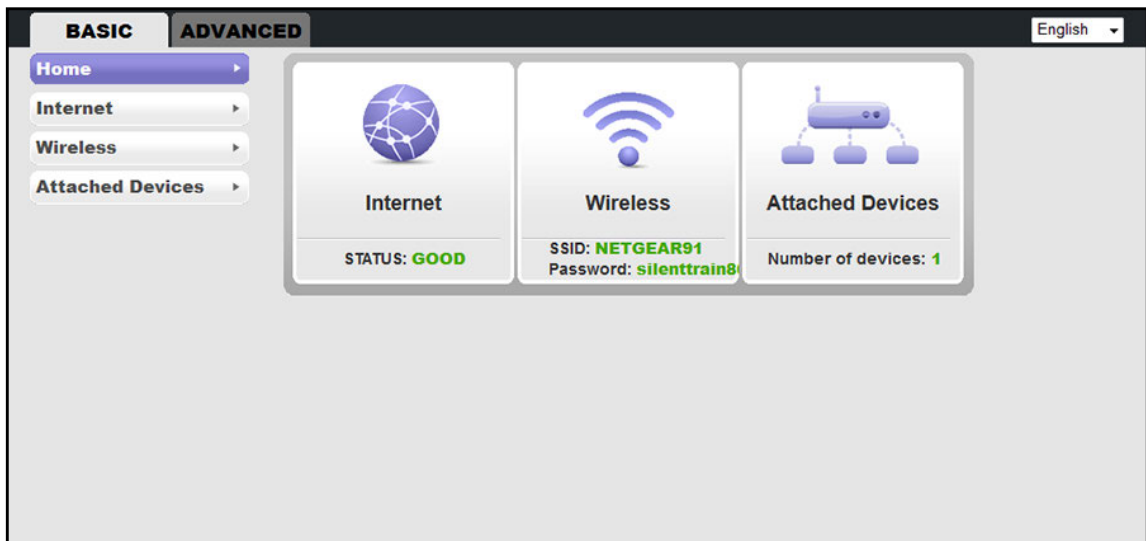

12. Change the default connection method:

- a. Select **ADVANCED > Setup > WAN Setup**.
- b. From the **WAN Preference** menu, select **Must use Ethernet WAN**.
- c. Click the **Apply** button.

The following message displays:

WAN physical interface changing. Please wait ...

You might need to wait a couple of minutes.

13. If the computer is disconnected from the modem router, reconnect the computer to the modem router (see [Step 8](#)), relaunch the web browser, and access NETGEAR genie again:

- a. In the address field of the web browser, enter **www.routerlogin.net**.
- b. When prompted, enter **admin** for the user name and **password** for the password.

The NETGEAR genie BASIC home screen displays again.

14. Select **ADVANCED > Setup Wizard**.

The Setup Wizard start screen displays.

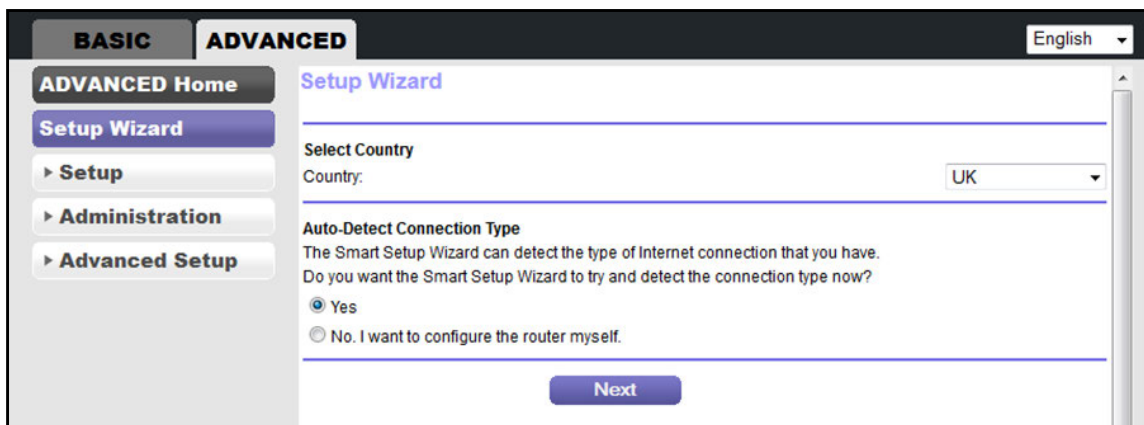

15. From the **Country** menu, select the country in which you use the modem router.
16. Select the **Yes** radio button.
17. Click the **Next** button.

The Setup Wizard searches your Internet connection for servers and protocols to determine your ISP configuration.

If the Internet connection is set up successfully, the Congratulation screen displays. If this screen does not display, see [Step 18](#).

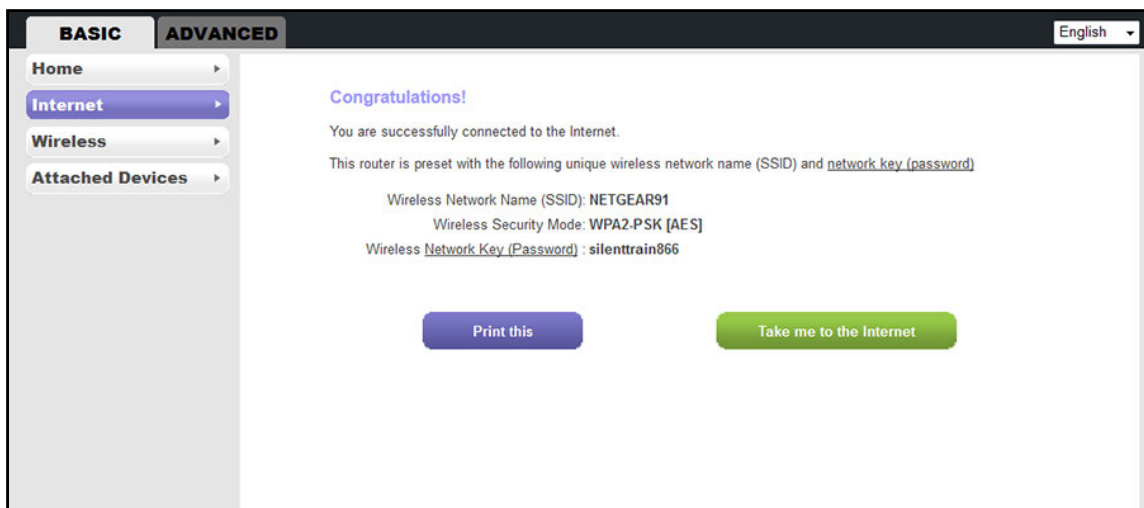

18. If the modem router does not connect to the Internet, do the following:
 - a. Review your settings. Make sure that you selected the correct options and typed everything correctly.
 - b. Contact your ISP to verify that you are using the correct configuration information.
 - c. Read [Troubleshoot the Internet Connection](#) on page 104. If problems persist, register your NETGEAR product and contact NETGEAR technical support.

Log In to the Modem Router After Setup to View or Change Settings

After you set up the modem router for DSL, cable, or fiber service, you can view or change the settings for the modem router by accessing NETGEAR genie.

➤ To log in to the modem router:

1. Launch an Internet browser from a computer or WiFi device that is connected to the network.
2. Type **http://www.routerlogin.net** or **http://www.routerlogin.com**.

A login screen displays. The nature of the login screen depends on your Internet browser.

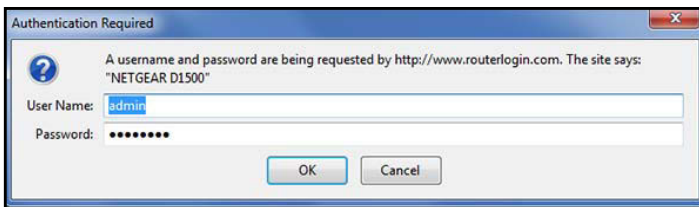

3. Enter the modem router user name and password.

The user name is **admin**. The default password is **password**. The user name and password are case-sensitive.

4. Click the **OK** button.

The BASIC Home screen displays.

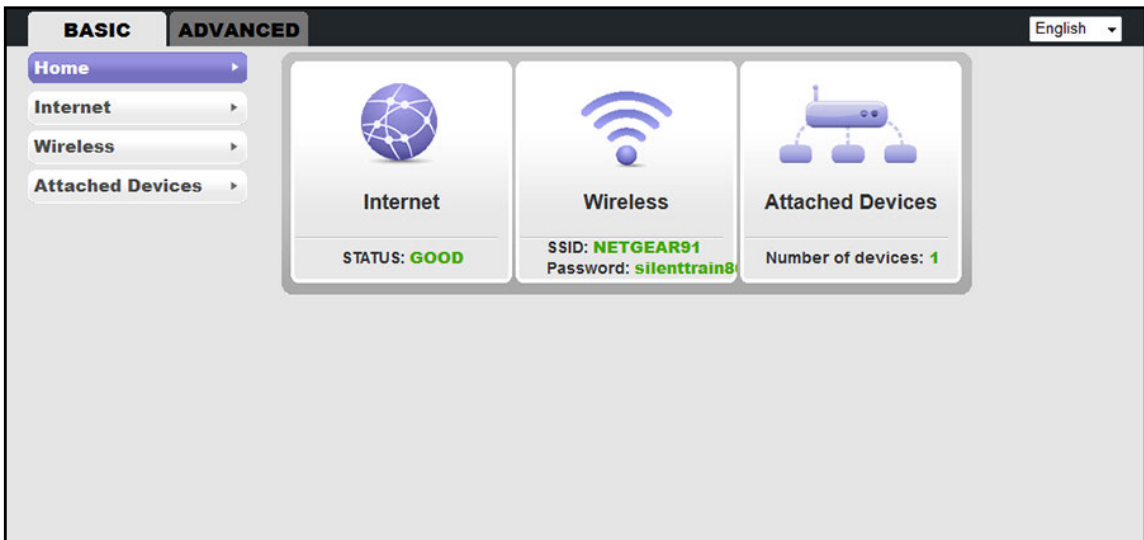

The BASIC Home screen displays a dashboard that lets you see the status of your Internet connection and network at a glance. You can click any of the three sections of the dashboard to view more detailed information. The left column displays the menus, and at the top is an ADVANCED tab that you can use to access more menus and screens.

Change the Language

By default, the language is set as Auto. You can change the language.

➤ **To change the language:**

1. Launch an Internet browser from a computer or WiFi device that is connected to the network.
2. Type **http://www.routerlogin.net** or **http://www.routerlogin.com**.
A login screen displays.
3. Enter the modem router user name and password.
The user name is **admin**. The default password is **password**. The user name and password are case-sensitive.
4. Click the **OK** button.
The BASIC Home screen displays.
5. In the upper right corner, select a language from the menu.
6. When prompted, click the **OK** button to confirm this change.
The screen refreshes with the language that you selected.

Change the admin Password and Automatic Login Time-Out

NETGEAR recommends that you change the default password that you use to log in to the modem router with a more secure password. This is the default password that you use to log in to the modem router with the user name admin.

Note: This admin password is *not* the password that you use for WiFi access. The label on your modem router shows your unique WiFi network name (SSID) and password for WiFi access.

➤ **To change the password for the user name admin:**

1. Launch an Internet browser from a computer or WiFi device that is connected to the network.
2. Type **http://www.routerlogin.net** or **http://www.routerlogin.com**.
A login screen displays.
3. Enter the user name and password for the modem router.
The user name is **admin**. The default password is **password**. The user name and password are case-sensitive.
4. Click the **OK** button.

The BASIC Home screen displays.

5. Select **ADVANCED > Administration > Set Password**.

The Set Password screen displays.

The screenshot shows the 'Set Password' configuration page. On the left is a navigation sidebar with 'ADVANCED' selected. The main area has a title 'Set Password' and two buttons: 'Cancel' and 'Apply'. Below the title are three input fields: 'Old Password', 'Set Password', and 'Repeat New Password'. A horizontal line separates this from a section where 'Administrator login times out after idle for' is set to '5' minutes. A vertical scrollbar is visible on the right side of the main content area.

6. Type the old password.
7. Type the new password twice.
8. To change the automatic login time-out, enter a new value in minutes in the field.

By default, you are logged out of the web management interface after five minutes of inactivity.

9. Click the **Apply** button.

Your changes take effect.

3

3 Manage the Internet Settings Manually

This chapter describes how you can manage the Internet settings of the modem router manually.

Usually, the quickest way to set up the modem router is to allow the NETGEAR genie automatic setup utility to detect the Internet connection when you first access the modem router with an Internet browser. For a cable or fiber service, you can use the Setup Wizard to detect the Internet connection. These options are described in *Chapter 2, Install and Access the Modem Router and Its Network*. You can also customize or specify your Internet settings manually.

The chapter contains the following sections:

- *Use the Internet Setup Wizard After Initial Setup*
- *Manually Set Up the Internet Connection*
- *Specify an IPv6 Internet Connection*
- *Manage the MTU Size*

Use the Internet Setup Wizard After Initial Setup

Whether you use DSL service or cable or fiber service, you can use the Setup Wizard to detect your Internet settings and automatically set up your modem router. If you use cable or fiber service, the default connection method must be Ethernet WAN for you to be able to use the Setup Wizard successfully. For more information about the default connection method, see [Change the WAN Connection Preference and Second Ethernet Port](#) on page 64.

Note: The Setup Wizard is not the same as the NETGEAR genie automatic setup utility that launches the first time you connect to your modem router in a DSL service setup.

➤ **To use the Setup Wizard:**

1. Launch an Internet browser from a computer or WiFi device that is connected to the network.
2. Type <http://www.routerlogin.net> or <http://www.routerlogin.com>.

A login screen displays.

3. Enter the modem router user name and password.

The user name is **admin**. The default password is **password**. The user name and password are case-sensitive.

4. Click the **OK** button.

The BASIC Home screen displays.

5. Select **ADVANCED > Setup Wizard**.

The Setup Wizard start screen displays.

6. From the **Country** menu, select the country in which you use the modem router.
7. Select the **Yes** radio button.

If you select the **No** radio button, you are taken to the Internet Setup screen (see [Manually Set Up the Internet Connection](#) on page 29).

8. Click the **Next** button.

The Setup Wizard searches your Internet connection for servers and protocols to determine your ISP configuration.

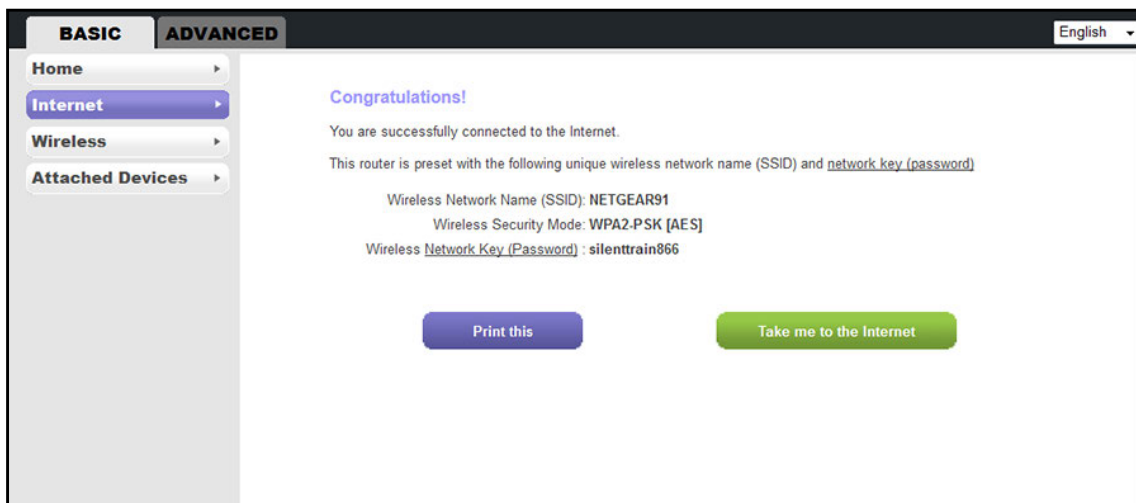

When you are connected to the Internet, the NETGEAR genie BASIC Home screen displays.

If this screen does not display, see [Step 9](#).

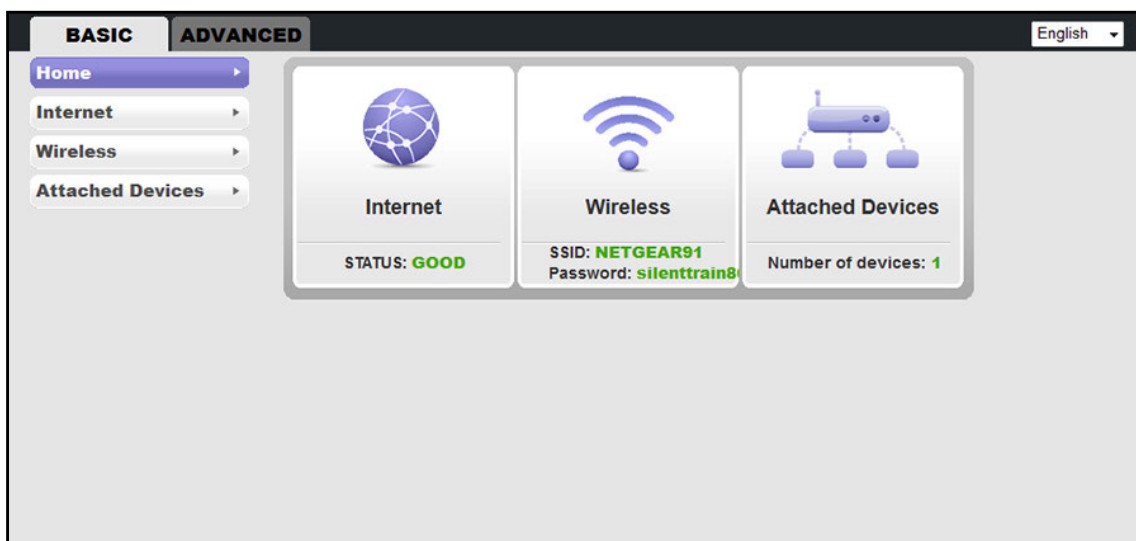

9. If the modem router does not connect to the Internet, do the following:
 - a. Review your settings. Make sure that you selected the correct options and typed everything correctly.
 - b. Contact your ISP to verify that you are using the correct configuration information.
 - c. Read [Troubleshoot the Internet Connection](#) on page 104. If problems persist, register your NETGEAR product and contact NETGEAR technical support.

Manually Set Up the Internet Connection

You can view or change the modem router's Internet connection settings manually. The following sections describe the options to manually set up the Internet connection:

- *Specify an Internet Connection Without a Login* on page 29
- *Specify an Internet Connection That Uses a Login and PPPoE Service* on page 31
- *Specify an Internet Connection That Uses a Login and PPPoA Service* on page 34

Specify an Internet Connection Without a Login

If you want to manually configure the Internet connection settings, use the information that your ISP gave you to log in to your Internet service. If you cannot find this information, contact your ISP.

➤ **To view or specify the Internet connection settings without a login:**

1. Launch an Internet browser from a computer or WiFi device that is connected to the network.
2. Type **http://www.routerlogin.net** or **http://www.routerlogin.com**.
A login screen displays.
3. Enter the modem router user name and password.
The user name is **admin**. The default password is **password**. The user name and password are case-sensitive.
4. Click the **OK** button.
The BASIC Home screen displays.
5. Select **Internet**.
The Internet Setup screen displays.
6. In the Does your Internet connection require a login? section, select the **No** radio button.
The screen adjusts.

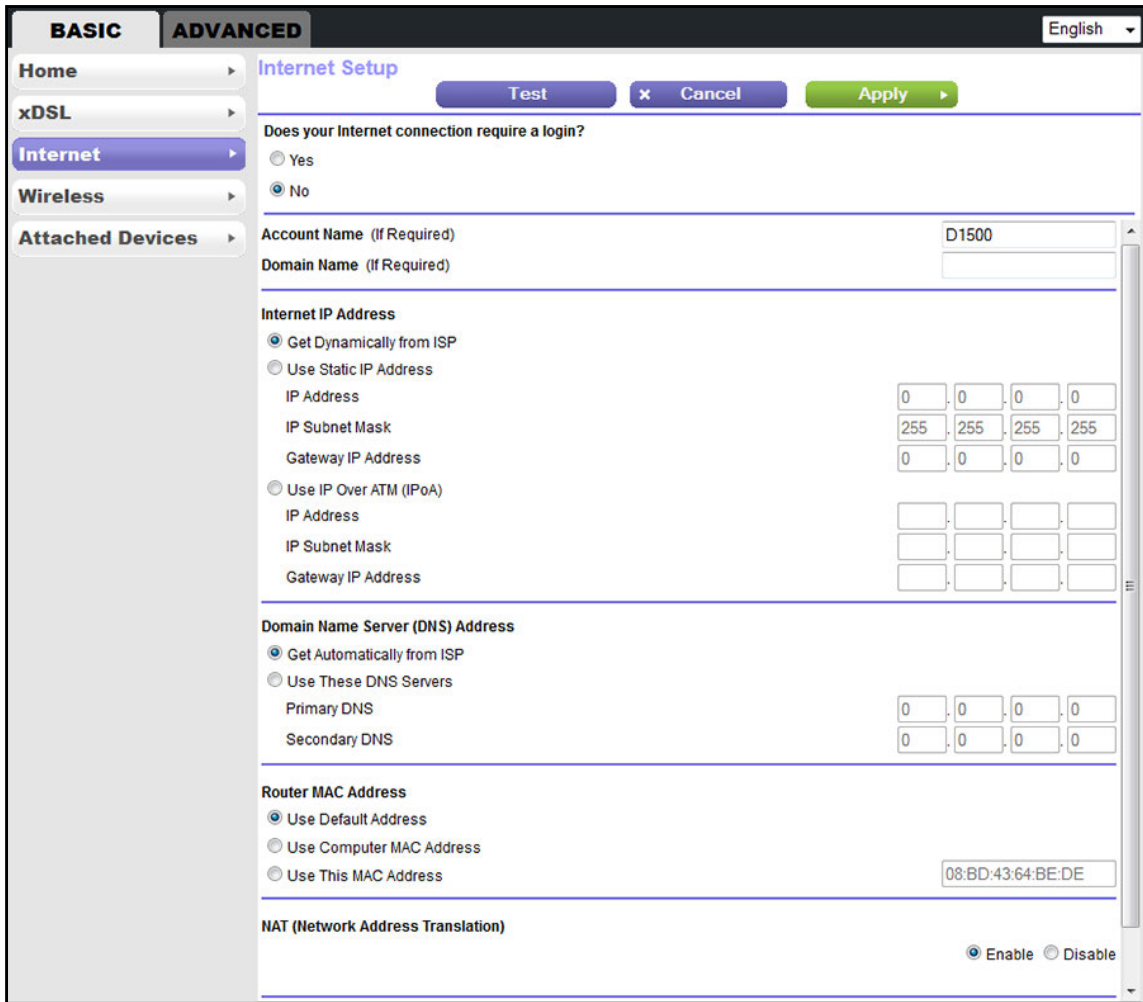

7. Enter the settings that are described in the following table.

Field	Description
Account Name (If Required)	Enter the account name provided by your ISP. This name might also be called the host name. If you do not know the account name, leave this field blank. By default, the Account Name field contains the model number of the modem router.
Domain Name (If Required)	Enter the domain name provided by your ISP. If you do not know the domain name, leave this field blank.
Internet IP Address	
Get Dynamically from ISP	Your ISP uses DHCP to assign your IP address. Your ISP automatically assigns these addresses.
Use Static IP Address	Enter the IP address, IP subnet mask, and gateway IP address that your ISP assigned for static IP address service. The gateway is the ISP router to which your modem router connects.

Field	Description
Use IP over ATM (IPoA)	Enter the IP address, IP subnet mask, and the gateway IP address that your ISP assigned for IPoA service. The gateway is the ISP router to which your modem router connects.
Domain Name Server (DNS) Address The DNS server is used to look up site addresses based on their names.	
Get Dynamically from ISP	Your ISP uses DHCP to assign your DNS servers. Your ISP automatically assigns this address.
Use These DNS Servers	If you know that your ISP does not automatically transmit DNS addresses to the modem router during login, select this option and enter the IP address of your ISP primary DNS server. If a secondary DNS server address is available, enter it also.
Router MAC Address The Ethernet MAC address that the modem router uses on the Internet port. Some ISPs register the MAC address of the network interface card in your computer when your account is first opened. They accept traffic only from the MAC address of that computer. This feature allows your modem router to use your computer's MAC address (also called cloning).	
Use Default Address	Use the default MAC address.
Use Computer MAC Address	The modem router captures and uses the MAC address of the computer that you are now using. You must use the one computer that is allowed by the ISP.
Use This MAC Address	Enter the MAC address that you want to use.
NAT (Network Address Translation) NAT allows computers on your home network to share the modem router Internet connection. NAT is enabled by default because it is needed in most situations. To specify the NAT setting, select one of the following radio buttons: <ul style="list-style-type: none"> • Enable. NAT is enabled. This is the default setting. • Disable. NAT is disabled. 	

8. Click the **Apply** button.

Your settings are saved.

9. Click the **Test** button to test your Internet connection.

If the NETGEAR website does not display within one minute, see [Troubleshoot the Internet Connection](#) on page 104.

Specify an Internet Connection That Uses a Login and PPPoE Service

If you want to manually configure the Internet connection settings, use the information that your ISP gave you to log in to your Internet service. If you cannot find this information, contact your ISP.

➤ **To view or specify the Internet connection settings with a login for PPPoE service:**

1. Launch an Internet browser from a computer or WiFi device that is connected to the network.
2. Type **http://www.routerlogin.net** or **http://www.routerlogin.com**.

A login screen displays.

3. Enter the modem router user name and password.

The user name is **admin**. The default password is **password**. The user name and password are case-sensitive.

4. Click the **OK** button.

The BASIC Home screen displays.

5. Select **Internet**.

The Internet Setup screen displays.

6. In the Does your Internet connection require a login? section, make sure that the **Yes** radio button is selected (it is selected by default).

7. From the **Encapsulation** menu, select **PPPoE (PPP over Ethernet)**.
8. Enter the settings that are described in the following table.

Field	Description
Login	Enter the login name that your ISP gave you. This login name is often an email address.
Password	Enter the password that you use to log in to your Internet service.
Service Name (If Required)	Enter the service name that your ISP gave you. Often, a service name is not required.
Connection Mode	From the Connection Mode menu, select Always On , Dial on Demand , or Manually Connect .
Idle Timeout (In Minutes)	To change the number of minutes until the Internet login times out, enter the number of minutes. The idle time-out specifies how long the modem router keeps the Internet connection active when no one on the network is using the Internet connection. A value of 0 (zero) means never log out.
Internet IP Address	
Get Dynamically from ISP	Your ISP uses DHCP to assign your IP address. Your ISP automatically assigns these addresses.
Use Static IP Address	Enter the IP address, IP subnet mask, and gateway IP address that your ISP assigned for static IP address service. The gateway is the ISP router to which your modem router connects.
Use IP over ATM (IPoA)	Enter the IP address, IP subnet mask, and gateway IP address that your ISP assigned for IPoA service. The gateway is the ISP router to which your modem router connects.
Domain Name Server (DNS) Address	
The DNS server is used to look up site addresses based on their names.	
Get Dynamically from ISP	Your ISP uses DHCP to assign your DNS servers. Your ISP automatically assigns this address.
Use These DNS Servers	If you know that your ISP does not automatically transmit DNS addresses to the modem router during login, select this option and enter the IP address of your ISP primary DNS server. If a secondary DNS server address is available, enter it also.
Router MAC Address	
The Ethernet MAC address that the modem router uses on the Internet port. Some ISPs register the MAC address of the network interface card in your computer when your account is first opened. They accept traffic only from the MAC address of that computer. This feature allows your modem router to use your computer's MAC address (also called cloning).	
Use Default Address	Use the default MAC address.
Use Computer MAC Address	The modem router captures and uses the MAC address of the computer that you are now using. You must use the one computer that is allowed by the ISP.

Field	Description
Use This MAC Address	Enter the MAC address that you want to use.
<p>NAT (Network Address Translation)</p> <p>NAT allows computers on your home network to share the modem router Internet connection. NAT is enabled by default because it is needed in most situations. To specify the NAT setting, select one of the following radio buttons:</p> <ul style="list-style-type: none"> • Enable. NAT is enabled. This is the default setting. • Disable. NAT is disabled. 	

9. Click the **Apply** button.

Your settings are saved.

10. Click the **Test** button to test your Internet connection.

If the NETGEAR website does not display within one minute, see [Troubleshoot the Internet Connection](#) on page 104.

Specify an Internet Connection That Uses a Login and PPPoA Service

If you want to manually configure the Internet connection settings, use the information that your ISP gave you to log in to your Internet service. If you cannot find this information, contact your ISP.

Note: PPP over ATM (PPPoA) is available only if you connect the modem router to the Internet over a DSL service. PPPoA is not available for cable or fiber service.

➤ **To view or specify the Internet connection settings with a login for PPPoA service:**

1. Launch an Internet browser from a computer or WiFi device that is connected to the network.

2. Type **http://www.routerlogin.net** or **http://www.routerlogin.com**.

A login screen displays.

3. Enter the modem router user name and password.

The user name is **admin**. The default password is **password**. The user name and password are case-sensitive.

4. Click the **OK** button.

The BASIC Home screen displays.

5. Select **Internet**.

The Internet Setup screen displays.

- In the Does your Internet connection require a login? section, make sure that the **Yes** radio button is selected (it is selected by default).

- From the **Encapsulation** menu, select **PPPoA (PPP over ATM)**.
- Enter the settings that are described in the following table.

Field	Description
Login	Enter the login name that your ISP gave you. This login name is often an email address.
Password	Enter the password that you use to log in to your Internet service.
Connection Mode	From the Connection Mode menu, select Always On , Dial on Demand , or Manually Connect .
Idle Timeout (In Minutes)	To change the number of minutes until the Internet login times out, enter the number of minutes. The idle time-out specifies how long the modem router keeps the Internet connection active when no one on the network is using the Internet connection. A value of 0 (zero) means never log out.
Account Name (If Required)	Enter the account name provided by your ISP. This name might also be called the host name. If you do not know the account name, leave this field blank.
Domain Name (If Required)	Enter the domain name provided by your ISP. If you do not know the domain name, leave this field blank.

Field	Description
Internet IP Address	
Get Dynamically from ISP	Your ISP uses DHCP to assign your IP address. Your ISP automatically assigns these addresses.
Use Static IP Address	Enter the IP address, IP subnet mask, and gateway IP address that your ISP assigned. The gateway is the ISP modem router to which your modem router connects.
Domain Name Server (DNS) Address The DNS server is used to look up site addresses based on their names.	
Get Dynamically from ISP	Your ISP uses DHCP to assign your DNS servers. Your ISP automatically assigns this address.
Use These DNS Servers	If you know that your ISP does not automatically transmit DNS addresses to the modem router during login, select this option and enter the IP address of your ISP primary DNS server. If a secondary DNS server address is available, enter it also.
NAT (Network Address Translation) NAT allows computers on your home network to share the modem router Internet connection. NAT is enabled by default because it is needed in most situations. To specify the NAT setting, select one of the following radio buttons: <ul style="list-style-type: none"> • Enable. NAT is enabled. This is the default setting. • Disable. NAT is disabled. 	

- Click the **Apply** button.

Your settings are saved.

- Click the **Test** button to test your Internet connection.

If the NETGEAR website does not display within one minute, see [Troubleshoot the Internet Connection](#) on page 104.

Specify an IPv6 Internet Connection

If you want to use an IPv6 Internet connection, you must specify the settings manually. NETGEAR genie does not detect an IPv6 Internet connection automatically.

IPv6 Internet Connections and IPv6 Addresses

The modem router can support an IPv6 Internet connection through the following connection types:

- **6to4 tunnel.** For more information, see [Set Up an IPv6 6to4 Tunnel Connection](#) on page 37.
- **Pass-through.** For more information, see [Set Up an IPv6 Pass-Through Connection](#) on page 39.

- **Fixed.** For more information, see [Set Up an IPv6 Fixed Connection](#) on page 39.
- **DHCP.** For more information, see [Set Up an IPv6 DHCP Connection](#) on page 41.
- **PPP over Ethernet.** For more information, see [Set Up an IPv6 PPPoE Connection](#) on page 43.

Which connection type you must use depends on your IPv6 ISP. Follow the directions that your IPv6 ISP gave you.

When you enable IPv6 and select any connection type other than IPv6 pass-through, the modem router starts the stateful packet inspection (SPI) firewall function on the WAN interface. The modem router creates connection records and checks every inbound IPv6 packet. If the inbound packet is not destined to the modem router itself and the modem router does not expect to receive such a packet, or the packet is not in the connection record, the modem router blocks this packet. This function works in two modes: In secured mode, the modem router inspects both TCP and UDP packets. In open mode, the modem router inspects UDP packets only.

IPv6 addresses are denoted by eight groups of hexadecimal quartets that are separated by colons. You can reduce any four-digit group of zeros within an IPv6 address to a single zero or omit it. The following errors invalidate an IPv6 address:

- More than eight groups of hexadecimal quartets
- More than four hexadecimal characters in a quartet
- More than two colons in a row

Set Up an IPv6 6to4 Tunnel Connection

With an IPv6 connection, your modem router creates a 6to4 tunnel to a remote relay router. Make sure that the IPv4 Internet connection is working before you apply the 6to4 tunnel settings for the IPv6 connection.

Note: Follow the directions that your IPv6 ISP gave you.

➤ To set up an IPv6 Internet connection by using a 6to4 tunnel:

1. Launch an Internet browser from a computer or WiFi device that is connected to the network.
2. Type <http://www.routerlogin.net> or <http://www.routerlogin.com>.
A login screen displays.
3. Enter the modem router user name and password.
The user name is **admin**. The default password is **password**. The user name and password are case-sensitive.
4. Click the **OK** button.
The BASIC Home screen displays.

5. Select **ADVANCED > Advanced Setup > IPv6**.

The IPv6 screen displays.

6. From the **Internet Connection Type** menu, select **6to4 Tunnel**.

The screen adjusts.

The modem router automatically detects the information in the **Router's IPv6 Address On LAN** field. This field shows the IPv6 address that is acquired for the modem router's LAN interface. The number after the slash (/) is the length of the prefix, which is also indicated by the underline () under the IPv6 address.

7. Select a Remote 6to4 Relay Router radio button:
 - **Auto.** Your modem router uses any remote relay modem router that is available on the Internet. This is the default setting.
 - **Static IP Address.** Enter the static IPv4 (*not* IPv6) address of the remote relay modem router. Your IPv6 ISP usually provides this address.
8. Select an IP Address Assignment radio button:
 - **Use DHCP Server.** The modem router assigns IPv6 addresses to the devices on your home network (the LAN) through a DHCP server. This method passes more information to LAN devices, but some IPv6 systems might not support the DHCv6 client function. This is the default setting.
 - **Auto Config.** The modem router automatically configures its IPv6 address based on the IPv6 protocol.
9. (Optional) Select the **Use This Interface ID** check box and specify the interface ID that you want to be used for the IPv6 address of the modem router's LAN interface.

If you do not specify an ID here, the modem router generates one automatically from its MAC address.

10. (Optional) Change the NAT filtering mode:

- **Secured.** In secured mode, the modem router inspects both TCP and UDP packets.
- **Open.** In open mode, the modem router inspects UDP packets only. This is the default mode.

11. Click the **Apply** button.

Your settings are saved.

Set Up an IPv6 Pass-Through Connection

In IPv6 pass-through mode, the modem router works as a Layer 2 Ethernet switch with two ports (LAN and WAN Ethernet ports) for IPv6 packets. The modem router does not process any IPv6 header packets.

Note: Follow the directions that your IPv6 ISP gave you.

➤ **To set up an IPv6 pass-through Internet connection:**

1. Launch an Internet browser from a computer or WiFi device that is connected to the network.

2. Type <http://www.routerlogin.net> or <http://www.routerlogin.com>.

A login screen displays.

3. Enter the modem router user name and password.

The user name is **admin**. The default password is **password**. The user name and password are case-sensitive.

4. Click the **OK** button.

The BASIC Home screen displays.

5. Select **ADVANCED > Advanced Setup > IPv6**.

The IPv6 screen displays.

6. From the **Internet Connection Type** menu, select **Pass Through**.

The screen adjusts, but no additional fields display.

7. Click the **Apply** button.

Your settings are saved.

Set Up an IPv6 Fixed Connection

A fixed IPv6 connection is based on a static or fixed IPv6 address that your IPv6 ISP gave you.

Note: Follow the directions that your IPv6 ISP gave you.

➤ **To set up a fixed IPv6 Internet connection:**

1. Launch an Internet browser from a computer or WiFi device that is connected to the network.
2. Type **http://www.routerlogin.net** or **http://www.routerlogin.com**.

A login screen displays.

3. Enter the modem router user name and password.

The user name is **admin**. The default password is **password**. The user name and password are case-sensitive.

4. Click the **OK** button.

The BASIC Home screen displays.

5. Select **ADVANCED > Advanced Setup > IPv6**.

The IPv6 screen displays.

6. From the **Internet Connection Type** menu, select **Fixed**.

The screen adjusts.

7. Configure the fixed IPv6 addresses for the WAN connection:
 - **IPv6 Address/Prefix Length.** The IPv6 address and prefix length of the modem router WAN interface.
 - **Default IPv6 Gateway.** The IPv6 address of the default IPv6 gateway for the modem router's WAN interface.

- **Primary DNS Server.** The primary DNS server that resolves IPv6 domain name records for the modem router.
- **Secondary DNS Server.** The secondary DNS server that resolves IPv6 domain name records for the modem router.

Note: If you do not specify the DNS servers, the modem router uses the DNS servers that are configured for the IPv4 Internet connection on the Internet Setup screen (see *Manually Set Up the Internet Connection* on page 29).

8. Select an IP Address Assignment radio button:
 - **Use DHCP Server.** The modem router assigns IPv6 addresses to the devices on your home network (the LAN) through a DHCP server. This method passes more information to LAN devices, but some IPv6 systems might not support the DHCv6 client function. This is the default setting.
 - **Auto Config.** The modem router automatically configures its IPv6 address based on the IPv6 protocol.

9. In the **IPv6 Address/Prefix Length** fields, specify the static IPv6 address and prefix length of the modem router's LAN interface.

If you do not specify an address here, the modem router generates one automatically from its MAC address.

10. (Optional) Change the NAT filtering mode:
 - **Secured.** In secured mode, the modem router inspects both TCP and UDP packets.
 - **Open.** In open mode, the modem router inspects UDP packets only. This is the default mode.

11. Click the **Apply** button.

Your settings are saved.

Set Up an IPv6 DHCP Connection

An IPv6 DHCP connection is based on a dynamic IPv6 address that a DHCPv6 server assigns to the modem router.

Note: Follow the directions that your IPv6 ISP gave you.

➤ **To set up an IPv6 Internet connection with a DHCP server:**

1. Launch an Internet browser from a computer or WiFi device that is connected to the network.
2. Type **<http://www.routerlogin.net>** or **<http://www.routerlogin.com>**.

A login screen displays.

3. Enter the modem router user name and password.
The user name is **admin**. The default password is **password**. The user name and password are case-sensitive.
4. Click the **OK** button.
The BASIC Home screen displays.
5. Select **ADVANCED > Advanced Setup > IPv6**.
The IPv6 screen displays.
6. From the **Internet Connection Type** menu, select **DHCP**.
The screen adjusts.

The modem router automatically detects the information in the following fields:

- **Router's IPv6 Address On WAN.** This field shows the IPv6 address that is acquired for the modem router's WAN (or Internet) interface. The number after the slash (/) is the length of the prefix, which is also indicated by the underline (_) under the IPv6 address. If no address is acquired, the field displays Not Available.
 - **Router's IPv6 Address On LAN.** This field shows the IPv6 address that is acquired for the modem router's LAN interface. The number after the slash (/) is the length of the prefix, which is also indicated by the underline (_) under the IPv6 address. If no address is acquired, the field displays Not Available.
7. (Optional) In the **User Class (if Required)** field, enter a host name.
Usually, you can leave this field blank, but if your IPv6 ISP gave you a specific host name, enter it here.
 8. (Optional) In the **Domain Name (if Required)** field, enter a domain name.

You can type the domain name of your IPv6 ISP. Do not enter the domain name for the IPv4 ISP here. For example, if your ISP's mail server is mail.xxx.yyy.zzz, type xxx.yyy.zzz as the domain name. If your ISP provided a domain name, type it in this field. For example, Earthlink Cable might require a host name of home, and Comcast sometimes supplies a domain name.

9. Select an IP Address Assignment radio button:
 - **Use DHCP Server.** The modem router assigns IPv6 addresses to the devices on your home network (the LAN) through a DHCP server. This method passes more information to LAN devices, but some IPv6 systems might not support the DHCv6 client function. This is the default setting.
 - **Auto Config.** The modem router automatically configures its IPv6 address based on the IPv6 protocol.

10. (Optional) Select the **Use This Interface ID** check box and specify the interface ID that you want to be used for the IPv6 address of the modem router's LAN interface.

If you do not specify an ID here, the modem router generates one automatically from its MAC address.

11. (Optional) Change the NAT filtering mode:
 - **Secured.** In secured mode, the modem router inspects both TCP and UDP packets.
 - **Open.** In open mode, the modem router inspects UDP packets only. This is the default mode.

12. Click the **Apply** button.

Your settings are saved.

Set Up an IPv6 PPPoE Connection

An IPv6 PPPoE connection is based on a dynamic IPv6 address that a PPPoE service assigns to the modem router.

Note: Follow the directions that your IPv6 ISP gave you.

➤ To set up an IPv6 PPPoE Internet connection:

1. Launch an Internet browser from a computer or WiFi device that is connected to the network.
2. Type <http://www.routerlogin.net> or <http://www.routerlogin.com>.
A login screen displays.
3. Enter the modem router user name and password.
The user name is **admin**. The default password is **password**. The user name and password are case-sensitive.
4. Click the **OK** button.

The BASIC Home screen displays.

5. Select **ADVANCED > Advanced Setup > IPv6**.

The IPv6 screen displays.

6. From the **Internet Connection Type** menu, select **PPPoE**.

The screen adjusts.

The modem router automatically detects the information in the following fields:

- **Router's IPv6 Address On WAN.** This field shows the IPv6 address that is acquired for the modem router's WAN (or Internet) interface. The number after the slash (/) is the length of the prefix, which is also indicated by the underline () under the IPv6 address. If no address is acquired, the field displays Not Available.
- **Router's IPv6 Address On LAN.** This field shows the IPv6 address that is acquired for the modem router's LAN interface. The number after the slash (/) is the length of the prefix, which is also indicated by the underline () under the IPv6 address. If no address is acquired, the field displays Not Available.

7. In the **Login** field, enter the login information for the ISP connection.

This is usually the name that you use in your email address. For example, if your main mail account is JerAB@ISP.com, you would type JerAB in this field. Some ISPs (such as Earthlink) require that you use your full email address when you log in. If your ISP requires your full email address, type it in this field.

8. In the **Password** field, enter the password for the ISP connection.
9. In the **Service Name** field, enter a service name.

If your ISP did not provide a service name, leave this field blank.

Note: The default setting of the **Connection Mode** menu is **Always On** to provide a steady IPv6 connection. The modem router never terminates the connection. If the connection is terminated, for example, when the modem is turned off, the modem router attempts to reestablish the connection immediately after the PPPoE connection becomes available again.

10. Select an IP Address Assignment radio button:

- **Use DHCP Server.** The modem router assigns IPv6 addresses to the devices on your home network (the LAN) through a DHCP server. This method passes more information to LAN devices, but some IPv6 systems might not support the DHCv6 client function. This is the default setting.
- **Auto Config.** The modem router automatically configures its IPv6 address based on the IPv6 protocol.

11. (Optional) Select the **Use This Interface ID** check box and specify the interface ID that you want to be used for the IPv6 address of the modem router's LAN interface.

If you do not specify an ID here, the modem router generates one automatically from its MAC address.

12. (Optional) Change the NAT filtering mode:

- **Secured.** In secured mode, the modem router inspects both TCP and UDP packets.
- **Open.** In open mode, the modem router inspects UDP packets only. This is the default mode.

13. Click the **Apply** button.

Your settings are saved.

Manage the MTU Size

The maximum transmission unit (MTU) is the largest data packet a network device transmits.

MTU Concepts

When one network device communicates across the Internet with another, the data packets travel through many devices along the way. If a device in the data path uses a lower MTU setting than the other devices, the data packets must be split or "fragmented" to accommodate the device with the smallest MTU.

The best MTU setting for NETGEAR equipment is often the default value. In some situations, changing the value fixes one problem but causes another.

Leave the MTU unchanged unless one of these situations occurs:

- You experience problems connecting to your ISP or other Internet service, and the technical support of either the ISP or NETGEAR recommends changing the MTU setting. These web-based applications might require an MTU change:
 - A secure website that does not open or displays only part of a web page
 - Yahoo email
 - MSN portal
 - America Online's DSL service
- You use VPN and experience severe performance problems.
- You used a program to optimize MTU for performance reasons and now you are experiencing connectivity or performance problems.

If you suspect an MTU problem, a common solution is to change the MTU to 1400. If you are willing to experiment, you can gradually reduce the MTU from the maximum value of 1500 until the problem goes away. The following table describes common MTU sizes and applications.

Table 2. Common MTU sizes

MTU	Application
1500	The largest Ethernet packet size. This setting is typical for connections that do not use PPPoE or VPN and is the default value for NETGEAR modem routers, adapters, and switches.
1492	Used in PPPoE environments.
1472	Maximum size to use for ping. (Larger packets are fragmented.)
1468	Used in some DHCP environments.
1460	Usable by AOL if you do not send or receive large email attachments, for example.
1436	Used in PPTP environments or with VPN.
1400	Maximum size for AOL DSL.
576	Typical value to connect to dial-up ISPs.

Change the MTU Size



WARNING:

An incorrect MTU setting can cause Internet communication problems. For example, you might not be able to access certain websites, frames within websites, secure login pages, or FTP or POP servers. Change the MTU only if you are sure that it is necessary for your ISP connection.

➤ **To change the MTU size:**

1. Launch an Internet browser from a computer or WiFi device that is connected to the network.
2. Type <http://www.routerlogin.net> or <http://www.routerlogin.com>.

A login screen displays.

3. Enter the modem router user name and password.

The user name is **admin**. The default password is **password**. The user name and password are case-sensitive.

4. Click the **OK** button.

The BASIC Home screen displays.

5. Select **ADVANCED > Setup > WAN Setup**.

The WAN Setup screen displays.

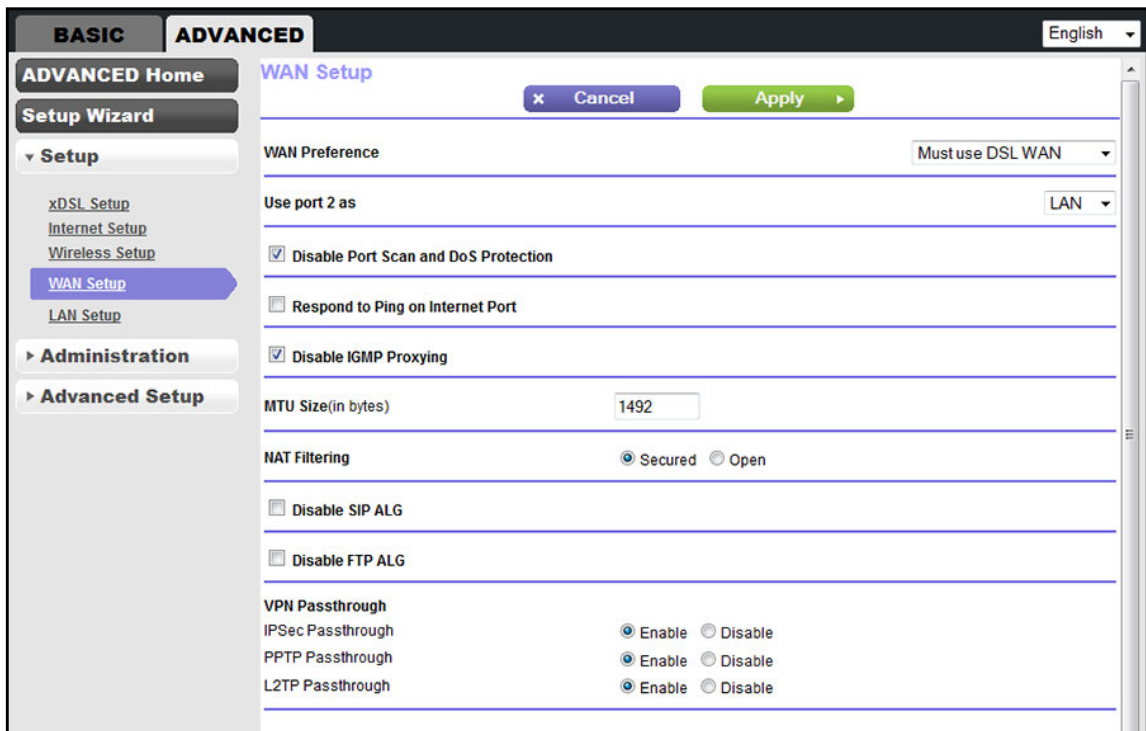

6. In the **MTU Size** field, enter a value from 616 to 1500.

The normal MTU (maximum transmit unit) value for most Ethernet networks is 1500 bytes, or 1492 bytes for PPPoE connections.

7. Click the **Apply** button.

Your change is saved.

4. Manage the WiFi Network Settings

4

This chapter describes how you can manage the WiFi network settings of the modem router.

The chapter includes the following sections:

- *Manage the Basic WiFi Settings and WiFi Security*
- *Manage the WiFi Radio*
- *Manage Advanced WiFi Features*
- *Set Up the Modem Router as a Wireless Repeater*

Manage the Basic WiFi Settings and WiFi Security

You can view or change the basic WiFi settings and WiFi security.

The modem router comes with preset security. This means that the WiFi network name (SSID), network key (password), and security option (encryption protocol) are preset in the factory. The preset SSID and password are uniquely generated for every device to protect and maximize your WiFi security. You can find the preset SSID and password on the product label (see *Bottom Panel Product Label* on page 10).

IMPORTANT:

NETGEAR recommends that you do *not* change your preset security settings. If you do decide to change your preset security settings, make a note of the new settings and store the note in a safe place where you can easily find it.

Note: If you want to change the modem router's WiFi settings, use a wired connection to avoid being disconnected when the new WiFi settings take effect.

➤ To view or change the basic WiFi settings:

1. Launch an Internet browser from a computer or WiFi device that is connected to the network.
2. Type <http://www.routerlogin.net> or <http://www.routerlogin.com>.
A login screen displays.
3. Enter the user name and password for the modem router.
The user name is **admin**. The default password is **password**. The user name and password are case-sensitive.
4. Click the **OK** button.
The BASIC Home screen displays.
5. Select **Wireless**.
The Wireless Settings screen displays.

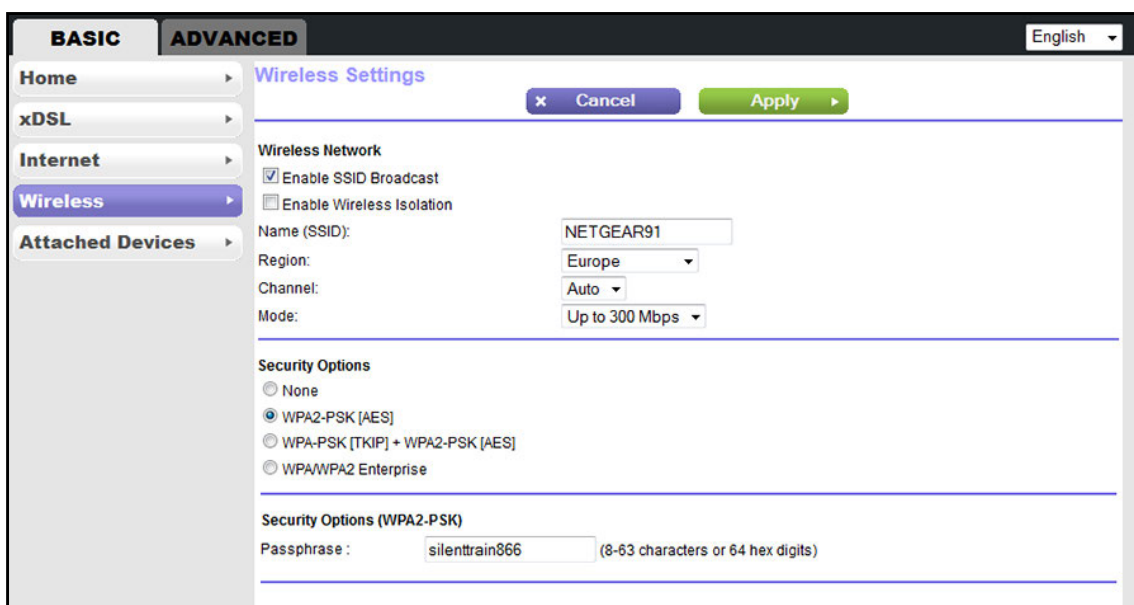

6. View or change the basic WiFi settings and security settings.

The following table describes the fields on the Wireless Settings screen.

Field	Description
Wireless Network	
Enable SSID Broadcast	By default, the modem router broadcasts its SSID so WiFi stations can detect the WiFi name (SSID) in their scanned network lists. To turn off the SSID broadcast, clear the Enable SSID Broadcast check box. Turning off the SSID broadcast provides additional WiFi security, but users must know the SSID to be able to join the WiFi network of the modem router.
Enable Wireless Isolation	By default, the modem router allows communication between WiFi clients that are connected to its WiFi network. Enabling wireless isolation might be a useful security measure if you use the modem router for a hotspot or other public WiFi network. To enable wireless isolation, select the Enable Wireless Isolation check box.
Name (SSID)	The SSID is the WiFi network name. If you did not change the SSID, the default SSID displays. The default SSID is also printed on the product label (see Bottom Panel Product Label on page 10). Note: NETGEAR recommends that you do not change the default SSID. If you must change the SSID, enter a 32-character (maximum), case-sensitive name in this field.
Region	From the Region menu, select the region in which you use the modem router. Note: In some locations, you cannot change the setting in the Region menu.

N150 and N300 WiFi DSL Modem Routers

Field	Description
Channel	<p>From the Channel menu, select Auto for automatic channel selection or select an individual channel. The default selection is Auto.</p> <p>Note: In some regions, not all channels are available. Do not change the channel unless you experience interference (shown by lost connections or slow data transfers). If this situation occurs, experiment with different channels to see which is the best.</p> <p>Note: If you use multiple WiFi access points (APs), reduce interference by selecting different channels for adjacent APs. NETGEAR recommends a channel spacing of four channels between adjacent APs (for example, use Channels 1 and 5, or 6 and 10).</p>
Mode	<p>The options from the Mode menu differ for the N150 WiFi DSL Modem Router Model 500 and the N300 WiFi DSL Modem Router Model D1500.</p> <p>N150 WiFi DSL Modem Router Model 500</p> <p>From the Mode menu, select one of the following modes:</p> <ul style="list-style-type: none"> • Up to 54 Mbps. Legacy mode. This mode allows 802.11n, 802.11g, and 802.11b devices to join the network but limits 802.11n devices to function at up to 54 Mbps. • Up to 65 Mbps. Neighbor-friendly mode for reduced interference with neighboring WiFi networks. This mode allows 802.11n, 802.11g, and 802.11b devices to join the network but limits 802.11n devices to function at up to 65 Mbps. • Up to 150 Mbps. Performance mode. This mode allows 802.11n, 802.11g, and 802.11b devices to join the network and allows 802.11n devices to function at up to 150 Mbps. This mode is the default mode. <p>Note: WPA-PSK security supports speeds of up to 54 Mbps. Even if your devices are capable of a higher speed, WPA-PSK security limits their speed to 54 Mbps.</p> <p>N300 WiFi DSL Modem Router Model D1500</p> <p>From the Mode menu, select one of the following modes:</p> <ul style="list-style-type: none"> • Up to 54 Mbps. Legacy mode. This mode allows 802.11n, 802.11g, and 802.11b devices to join the network but limits 802.11n devices to function at up to 54 Mbps. • Up to 145 Mbps. Neighbor-friendly mode for reduced interference with neighboring WiFi networks. This mode allows 802.11n, 802.11g, and 802.11b devices to join the network but limits 802.11n devices to function at up to 145 Mbps. • Up to 300 Mbps. Performance mode. This mode allows 802.11n, 802.11g, and 802.11b devices to join the network and allows 802.11n devices to function at up to 300 Mbps. This mode is the default mode. <p>Note: WPA-PSK security supports speeds of up to 54 Mbps. Even if your devices are capable of a higher speed, WPA-PSK security limits their speed to 54 Mbps.</p>

Field	Description
Security Options	
<p>Note: NETGEAR recommends that you do <i>not</i> change your preset security settings (WPA-PSK [TKIP] + WPA2-PASK [AES]).</p> <p>If you must change the WiFi security, select one of the following WiFi security options for the modem router's WiFi network:</p> <ul style="list-style-type: none"> • None. An open WiFi network that does not provide any security. Any WiFi device can join the network. NETGEAR recommends that you do <i>not</i> use an open WiFi network. • WEP. Wired Equivalent Privacy (WEP) security is a legacy authentication and data encryption mode that is superseded by WPA-PSK and WPA2-PSK. The WEP option displays only if you select Up to 54 Mbps from the Mode menu. WEP limits the WiFi transmission speed to 54 Mbps (the modem router is capable of speeds of up to 300 Mbps). For information about configuring WEP, see Configure WEP Legacy WiFi Security on page 54. • WPA2-PSK [AES]. WPA2 provides a secure connection but some older WiFi devices do not detect WPA2 and support only WPA. If your network includes such older devices, select WPA-PSK [TKIP] + WPA2-PASK [AES] security. To use this type of security, in the Passphrase field, enter a phrase of 8 to 63 characters. To join the modem router's WiFi network, a user must enter this passphrase. • WPA-PSK [TKIP] + WPA2-PASK [AES]. This type of security is the default setting and enables WiFi devices that support either WPA or WPA2 to join the modem router's WiFi network. If you did not change the passphrase, the default passphrase displays. The default passphrase is printed on the product label (see Bottom Panel Product Label on page 10). NETGEAR recommends that you do not change the default passphrase. If you must change the passphrase, in the Passphrase field, enter a phrase of 8 to 63 characters. To join the modem router's WiFi network, a user must enter this passphrase. • WPA/WPA2 Enterprise. This type of security requires that your WiFi network can access a RADIUS server. For information about configuring WPA/WPA2 Enterprise, see Configure WPA/WPA2 Enterprise WiFi Security on page 53. 	

7. Click the **Apply** button.

Your settings are saved.

If you connected over WiFi to the network and you changed the SSID, you are disconnected from the network.

8. Make sure that you can reconnect over WiFi to the network with its new settings.

If you cannot connect over WiFi, check the following:

- If your computer or WiFi device is already connected to another WiFi network in your area, disconnect it from that WiFi network and connect it to the WiFi network that the modem router provides. Some WiFi devices automatically connect to the first open network without WiFi security that they discover.
- If your computer or WiFi device is trying to connect to your network with its old settings (before you changed the settings), update the WiFi network selection in your computer or WiFi device to match the current settings for your network.

Configure WPA/WPA2 Enterprise WiFi Security

Remote Authentication Dial In User Service (RADIUS) is an enterprise-level method for centralized Authentication, Authorization, and Accounting (AAA) management. To provide WPA/WPA2 enterprise WiFi security, the WiFi network that the modem router provides must be able to access a RADIUS server.

➤ **To configure WPA/WPA2 enterprise security:**

1. Launch an Internet browser from a computer or WiFi device that is connected to the network.

2. Type <http://www.routerlogin.net> or <http://www.routerlogin.com>.

A login screen displays.

3. Enter the user name and password for the modem router.

The user name is **admin**. The default password is **password**. The user name and password are case-sensitive.

4. Click the **OK** button.

The BASIC Home screen displays.

5. Select **Wireless**.

The Wireless Settings screen displays.

6. In the Security Options section, select the **WPA/WPA2 Enterprise** radio button.

The screen adjusts again to display the WPA/WPA2 enterprise options.

The screenshot shows the 'Wireless Settings' page in the router's web interface. The 'ADVANCED' tab is selected. The 'Wireless Network' section includes checkboxes for 'Enable SSID Broadcast' (checked) and 'Enable Wireless Isolation' (unchecked). The 'Name (SSID):' field contains 'NETGEAR91'. The 'Region:' dropdown is set to 'Europe', 'Channel:' is 'Auto', and 'Mode:' is 'Up to 54 Mbps'. The 'Security Options' section has radio buttons for 'None', 'WEP', 'WPA2-PSK [AES]', 'WPA-PSK [TKIP] + WPA2-PSK [AES]', and 'WPA/WPA2 Enterprise' (selected). Below this, the 'Security Options (WPA/WPA2 Enterprise)' section shows 'WPA Mode:' set to 'WPA [TKIP] + WPA2 [AES]', 'RADIUS server IP Address:' with four empty fields, 'RADIUS server Port:' set to '1812', and 'RADIUS server Shared Secret:' with an empty field. 'Cancel' and 'Apply' buttons are at the top right.

7. In the Security Options (WPA/WPA2 Enterprise) section, enter the settings that are described in the following table.

Field	Description
WPA Mode	From the WPA Mode menu, select the enterprise mode: <ul style="list-style-type: none"> • WPA2 [AES]. WPA2 provides a secure connection but some older WiFi devices do not detect WPA2 and support only WPA. If your network includes such older devices, select WPA [TKIP] + WPA2 [AES] security. • WPA [TKIP] +WPA2 [AES]. This type of security enables WiFi devices that support either WPA or WPA2 to join the modem router's WiFi network.
RADIUS server IP Address	Enter the IPv4 address of the RADIUS server to which the WiFi network can connect.
RADIUS server Port	Enter the number of the port on the modem router that is used to access the RADIUS server for authentication. The default port number is 1812.
RADIUS server Shared Secret	Enter the shared secret (RADIUS password) that is used between the modem router and the RADIUS server during authentication of a WiFi user.

8. Click the **Apply** button.

Your settings are saved.

9. Make sure that you can reconnect over WiFi to the network with its new security settings.

If you cannot connect over WiFi, check the following:

- If your computer or WiFi device is already connected to another WiFi network in your area, disconnect it from that WiFi network and connect it to the WiFi network that the modem router provides. Some WiFi devices automatically connect to the first open network without WiFi security that they discover.
- If your computer or WiFi device is trying to connect to your network with its old settings (before you changed the settings), update the WiFi network selection in your computer or WiFi device to match the current settings for your network.

Configure WEP Legacy WiFi Security

Wired Equivalent Privacy (WEP) security is a legacy authentication and data encryption mode that is superseded by WPA-PSK and WPA2-PSK. WEP limits the WiFi transmission speed to 54 Mbps (depending on the model, the modem router is capable of speeds of up to 300 Mbps).

➤ To configure WEP security:

1. Launch an Internet browser from a computer or WiFi device that is connected to the network.
2. Type <http://www.routerlogin.net> or <http://www.routerlogin.com>.

A login screen displays.

3. Enter the user name and password for the modem router.
The user name is **admin**. The default password is **password**. The user name and password are case-sensitive.
4. Click the **OK** button.
The BASIC Home screen displays.
5. Select **Wireless**.
The Wireless Settings screen displays.
6. From the **Mode** menu, select **Up to 54 Mbps**.
The screen adjusts to display the **WEP** radio button.
7. In the Security Options section, select the **WEP** radio button.
The screen adjusts again to display the WEP options.

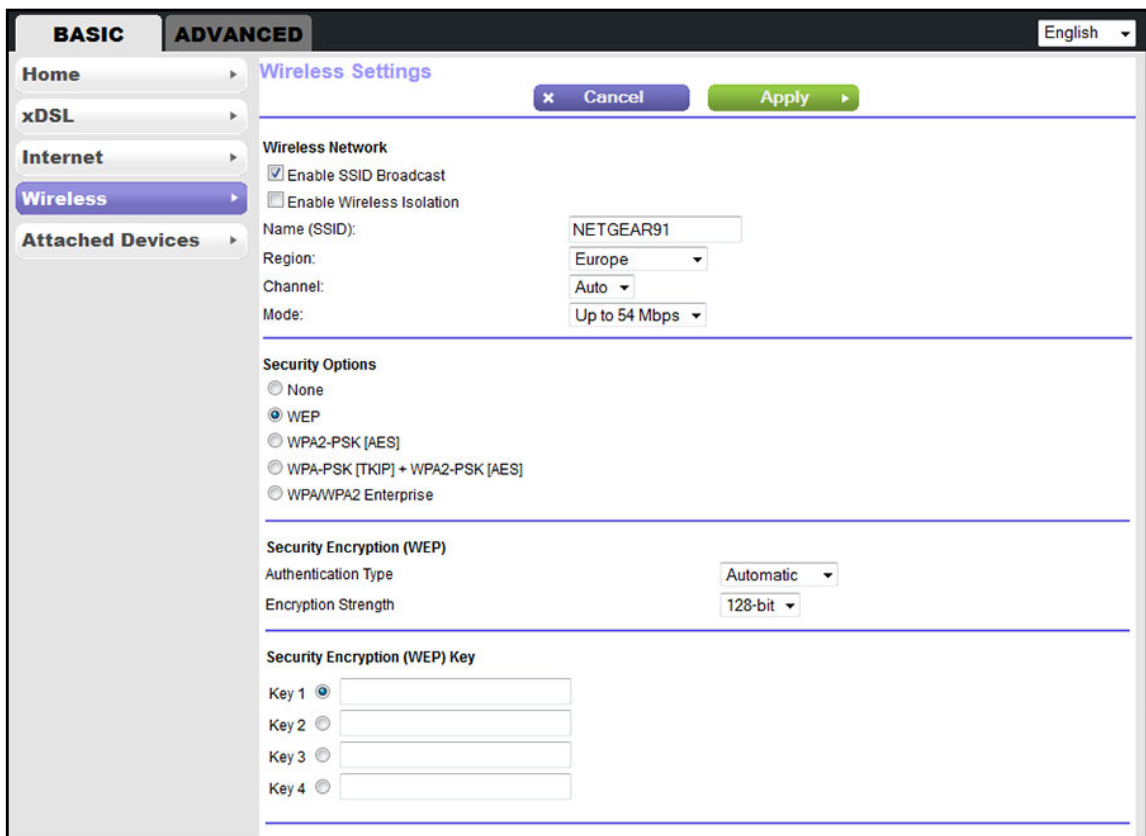

8. From the **Authentication Type** menu, select one of the following types:
 - **Shared Key**. Clients can use only Shared Key authentication.
 - **Automatic**. Clients can use either Open System or Shared Key authentication.

9. From the **Encryption Strength** menu, select the encryption key size:
 - **64-bit.** Standard WEP encryption, using 40/64-bit encryption.
 - **128-bit.** Standard WEP encryption, using 104/128-bit encryption. This selection provides higher encryption security.
10. Specify the active key by selecting the **Key 1**, **Key 2**, **Key 3**, or **Key 4** radio button.

Only one key can be the active key.
11. Enter the value for the key:
 - For 64-bit WEP, enter 10 hexadecimal digits (any combination of 0–9, A–F). The key values are not case-sensitive.
 - For 128-bit WEP, enter 26 hexadecimal digits (any combination of 0–9, A–F). The key values are not case-sensitive.

To join the modem router's WiFi network, a user must enter the key value for the key that you specified as the active key.
12. Click the **Apply** button.

Your settings are saved.
13. Make sure that you can reconnect over WiFi to the network with its new security settings.

If you cannot connect over WiFi, check the following:

 - If your computer or WiFi device is already connected to another WiFi network in your area, disconnect it from that WiFi network and connect it to the WiFi network that the modem router provides. Some WiFi devices automatically connect to the first open network without WiFi security that they discover.
 - If your computer or WiFi device is trying to connect to your network with its old settings (before you changed the settings), update the WiFi network selection in your computer or WiFi device to match the current settings for your network.

Manage the WiFi Radio

The router includes an internal WiFi radio that broadcast a signal in the 2.4 GHz range. By default, the radio is on so that you can connect over WiFi to the modem router. You might sometimes want to turn off the WiFi radio. If you disable the WiFi radio, you can still use an Ethernet cable for a LAN connection to the modem router.

Note: If you want to disable the modem router's WiFi radio, use a wired connection to avoid being disconnected when the WiFi radio is disabled.

➤ **To manage the WiFi radio:**

1. Launch an Internet browser from a computer or WiFi device that is connected to the network.

2. Type <http://www.routerlogin.net> or <http://www.routerlogin.com>.

A login screen displays.

3. Enter the user name and password for the modem router.

The user name is **admin**. The default password is **password**. The user name and password are case-sensitive.

4. Click the **OK** button.

The BASIC Home screen displays.

5. Select **ADVANCED > Advanced Setup > Wireless Settings**.

The Advanced Wireless Settings screen displays.

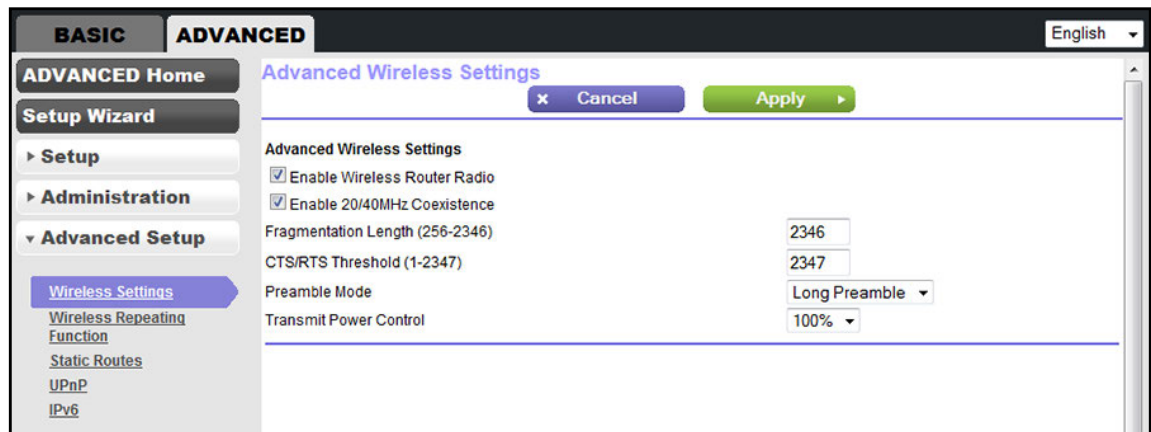

6. Do one of the following:

- **Turn off the radio.** Clear the **Enable Wireless Radio** check box.

The WiFi LED turns off (see [Top Panel with LEDs](#) on page 8).

- **Turn on the radio.** Select the **Enable Wireless Radio** check box.

The WiFi LED lights solid green.

7. Click the **Apply** button.

Your settings are saved.

Manage Advanced WiFi Features

For most WiFi networks, the advanced WiFi features work fine and you do not need to change the settings.

Note: If you want to change the modem router's advanced WiFi features, use a wired connection to avoid being disconnected when the changes take effect.

➤ **To manage advanced WiFi features:**

1. Launch an Internet browser from a computer or WiFi device that is connected to the network.
2. Type <http://www.routerlogin.net> or <http://www.routerlogin.com>.

A login screen displays.

3. Enter the user name and password for the modem router.

The user name is **admin**. The default password is **password**. The user name and password are case-sensitive.

4. Click the **OK** button.

The BASIC Home screen displays.

5. Select **ADVANCED > Advanced Setup > Wireless Settings**.

The Advanced Wireless Settings screen displays.

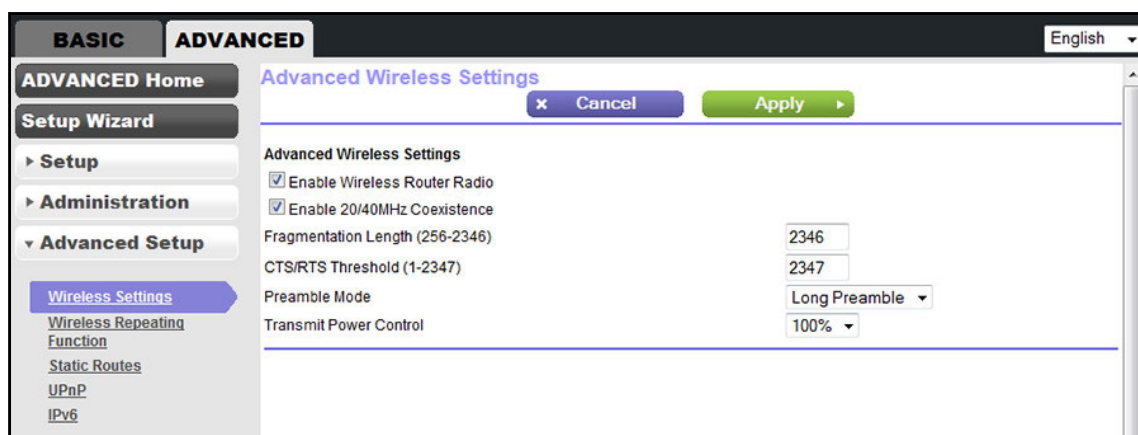

6. Enter the settings that are described in the following table.

Field	Description
Enable 20/40 MHz Coexistence	By default, 20/40 MHz coexistence is enabled to prevent interference between WiFi networks in your environment at the expense of the WiFi speed. If no other WiFi networks are present in your environment, you can clear the Enable 20/40 MHz Coexistence check box to increase the WiFi speed to the maximum supported speed.
Fragmentation Length (256-2346)	The fragmentation length (the default is 2346), CTS/RTS threshold (the default is 2347), and the preamble mode (the default is Long Preamble) are reserved for WiFi testing and advanced configuration only. Do not change these settings unless directed by NETGEAR support or unless you are sure what the consequences are. Incorrect settings might disable the WiFi function of the modem router unexpectedly.
CTS/RTS Threshold (1-2347)	
Preamble Mode	
Transmit Power Control	You can lower the WiFi transmit power by selecting a value lower than 100% from the Transmit Power Control menu. The setting of 100% allows the modem router to use the maximum WiFi transmit power to transmit WiFi packets. Reducing the transmit power can save the power consumption for the modem router but also reduces the WiFi coverage. If you want to ensure maximum WiFi coverage, NETGEAR recommends that you leave the setting on the Transmit Power Control menu at 100%.

7. Click the **Apply** button.

Your settings are saved.

Set Up the Modem Router as a Wireless Repeater

The modem router can function as a wireless repeater for an existing WiFi network by connecting to an SSID of another WiFi router. In such a setup, the modem router sends all outgoing traffic to the other WiFi router and receives all incoming traffic from the WiFi router. When the modem router functions as a wireless repeater, it can support both WiFi and wired clients but connects to the Internet through the WiFi router. This WiFi router and its WiFi network are referred to as the uplink.

When you enable the repeating function, the built-in DHCP server of the modem router becomes disabled. Make sure that the IP address of the modem router is not identical to the IP address of the uplink WiFi router, the local gateway, or another device on the network of the uplink WiFi router. For information about changing the IP address of the modem router, see [Manage the Modem Router's LAN IP Address](#) on page 71.

Before you can enable the modem router as a WiFi repeater, you must know the network key (password) of the WiFi network that you want to connect to.

Note: If you want to change the modem router's WiFi settings, use a wired connection to avoid being disconnected when the new WiFi settings take effect.

The following figure shows a wireless repeating scenario.

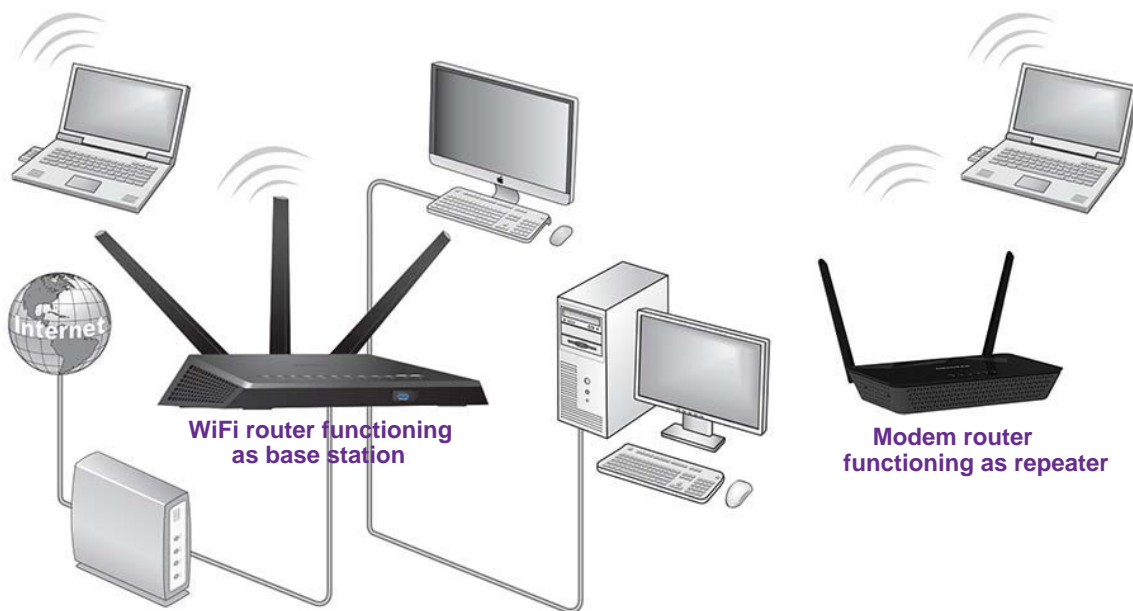
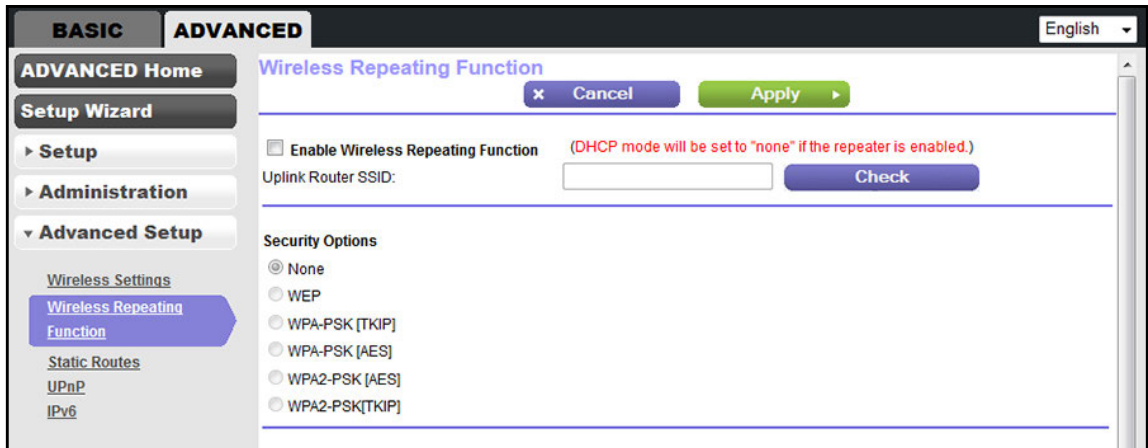

Figure 9. Wireless repeating scenario

- **To configure the modem router as a repeater for an uplink WiFi network:**
 1. Launch an Internet browser from a computer or WiFi device that is connected to the network of the router to be the repeater.
 2. Type **<http://www.routerlogin.net>** or **<http://www.routerlogin.com>**.
A login screen displays.
 3. Enter the user name and password for the modem router.
The user name is **admin**. The default password is **password**. The user name and password are case-sensitive.
 4. Click the **OK** button.
The BASIC Home screen displays.
 5. Select **ADVANCED > Advanced Setup > Wireless Repeating Function**.
The Wireless Repeating Function screen displays.



6. Select the **Enable Wireless Repeating Function** check box.
7. Click the **Check** button.

The modem router checks for available WiFi networks. The Wireless Repeating Function screen adjusts to show the detected WiFi networks.

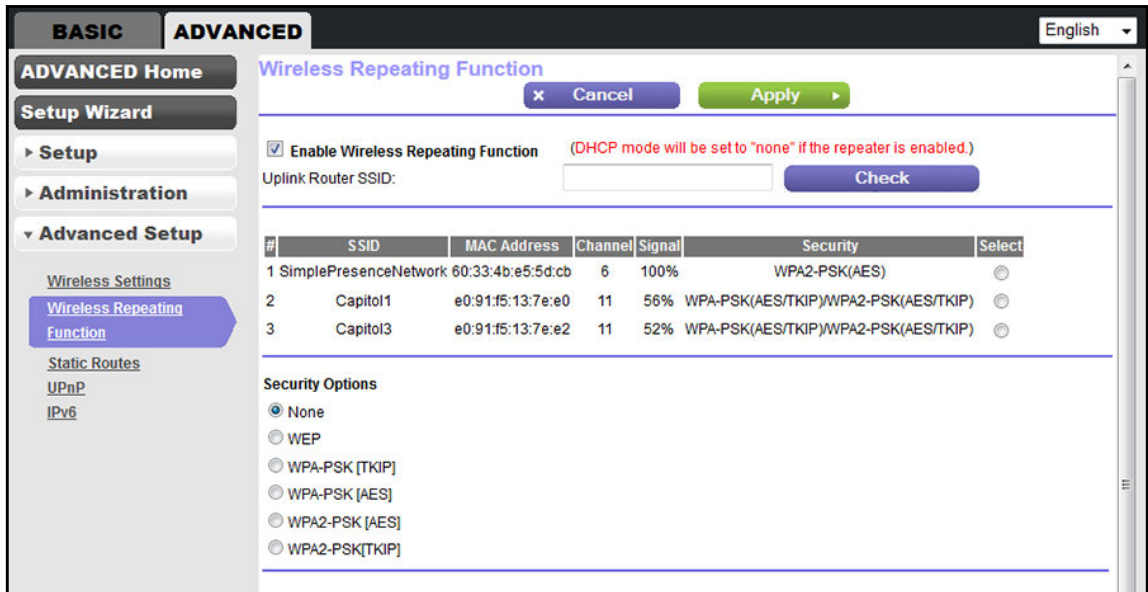

8. Select the radio button that corresponds to the WiFi network that must function as the uplink. The screen adjusts to show the security option for the selected WiFi network. The **Uplink Router SSID** field shows the selected WiFi network.

5 Manage the WAN and LAN Network Settings

This chapter describes how you can manage the WAN and LAN network settings of the modem router.

The chapter includes the following sections:

- *Manage the ADSL Settings*
- *Change the WAN Connection Preference and Second Ethernet Port*
- *Manage the WAN Security Settings*
- *Manage IGMP Proxying and VPN Pass-Through*
- *Manage NAT Filtering*
- *Manage the Application Level Gateway*
- *Manage the Modem Router's LAN IP Address*
- *Change the Modem Router's Device Name*
- *Manage the DHCP Server Address Pool*
- *Disable the Built-In DHCP Server*
- *Set Up and Manage Static Routes*
- *Manage Universal Plug and Play*

Manage the ADSL Settings

NETGEAR recommends that you use the NETGEAR genie automatic setup utility to detect the DSL connection and automatically set up the modem router (see *Set Up Your Modem Router for DSL Service* on page 15).

If you are technically experienced and are sure of the correct DSL mode, multiplexing method, and virtual circuit number for the virtual path identifier (VPI) and virtual channel identifier (VCI), you can change those settings. NETGEAR recommends that you enter the multiplexing method, VPI, and VCI only if your ISP gave you this information.

➤ To view or change the DSL setup:

1. Launch an Internet browser from a computer or WiFi device that is connected to the network.
2. Type <http://www.routerlogin.net> or <http://www.routerlogin.com>.

A login screen displays.

3. Enter the user name and password for the modem router.

The user name is **admin**. The default password is **password**. The user name and password are case-sensitive.

4. Click the **OK** button.

The BASIC Home screen displays.

5. Select **ADVANCED > Setup > ADSL Settings**.

The xDSL Setup screen displays.

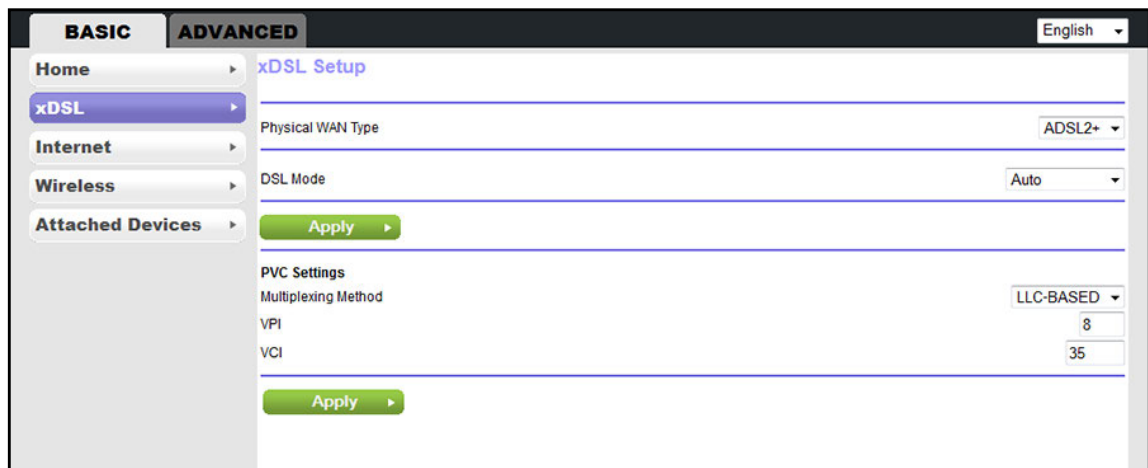

The selection from the **Physical WAN Type** menu is fixed at **ADSL2+**.

6. From the **DSL Mode** menu, select the DSL mode that your ISP provided you:
 - **Auto**. The modem router detects the DSL mode automatically. This is the default setting.
 - **ADSL (g.dmt)**. Legacy version of ADSL.

- **ADSL2.** Legacy version of ADSL2.
 - **ADSL2+.** ADSL2+ provides the fastest downstream rates and can interoperate with ADSL2 and ADSL (g.dmt).
7. Click the upper **Apply** button.
Your DSL mode changes are saved.
 8. From the **Multiplexing Method** menu, select **LLC-based** or **VC-based**, as indicated by your ISP.
 9. For the VPI, type a number between 0 and 255, as indicated by your ISP.
The default setting is 8.
 10. For the VCI, type a number between 32 and 65535, as indicated by your ISP.
The default setting is 35.
 11. Click the lower **Apply** button.
Your PVC changes are saved.

Change the WAN Connection Preference and Second Ethernet Port

When you set up the modem router for cable or fiber (Ethernet WAN) service, you must change the default WAN connection preference (see *Set Up Your Modem Router for Cable or Fiber Service* on page 18). If you want to change the WAN connection preference, use the information in this section.

The default WAN connection preference is to use the ADSL port for an Internet connection over DSL service. With this option, both Ethernet ports are available for LAN connections. The other WAN connection preference is to use Ethernet port 2 for an Internet connection over cable or fiber service. With this option, only Ethernet port 1 is available for a LAN connection.

- **To change the WAN connection preference and assignment of Ethernet port 2:**
 1. Launch an Internet browser from a computer or WiFi device that is connected to the network.
 2. Type **http://www.routerlogin.net** or **http://www.routerlogin.com**.
A login screen displays.
 3. Enter the user name and password for the modem router.
The user name is **admin**. The default password is **password**. The user name and password are case-sensitive.
 4. Click the **OK** button.
The BASIC Home screen displays.

5. Select **ADVANCED > Setup > WAN Setup**.

The WAN Setup screen displays.

The screenshot shows the WAN Setup configuration page. The left sidebar contains a navigation menu with 'ADVANCED Home', 'Setup Wizard', and a 'Setup' section containing links for 'xDSL Setup', 'Internet Setup', 'Wireless Setup', 'WAN Setup' (highlighted), and 'LAN Setup'. Below this are 'Administration' and 'Advanced Setup' sections. The main content area is titled 'WAN Setup' and includes a 'Cancel' button and an 'Apply' button. The configuration options are as follows:

- WAN Preference:** Must use DSL WAN
- Use port 2 as:** LAN
- Disable Port Scan and DoS Protection**
- Respond to Ping on Internet Port**
- Disable IGMP Proxying**
- MTU Size(in bytes):** 1492
- NAT Filtering:** Secured (selected), Open
- Disable SIP ALG**
- Disable FTP ALG**
- VPN Passthrough:**
 - IPSec Passthrough: Enable (selected), Disable
 - PPTP Passthrough: Enable (selected), Disable
 - L2TP Passthrough: Enable (selected), Disable

6. From the **WAN Preference** menu, select one of the following options:

- **Must use DSL WAN.** The modem router uses the ADSL port for an Internet connection over DSL service and both Ethernet ports are available for LAN connections. The selection from the **Use port 2 as** menu changes automatically to **LAN**.
- **Must use Ethernet WAN.** The modem router uses Ethernet port 2 for an Internet connection over cable or fiber service and only Ethernet port 1 is available for a LAN connection. The selection from the **Use port 2 as** menu changes automatically to **WAN**.

7. Click the **Apply** button.

Your changes are saved.

Manage the WAN Security Settings

The WAN security settings include port scan protection and denial of service (DoS) protection, which can protect your LAN against attacks such as Syn flood, Smurf Attack, Ping of Death, and many others. By default, DoS protection is disabled and a port scan is rejected.

You can also enable the modem router to respond to a ping to its WAN (Internet) port. This feature allows your modem router to be discovered. Enable this feature only as a diagnostic tool or if a specific reason exists.

➤ To change the default WAN security settings:

1. Launch an Internet browser from a computer or WiFi device that is connected to the network.
2. Type <http://www.routerlogin.net> or <http://www.routerlogin.com>.

A login screen displays.

3. Enter the user name and password for the modem router.

The user name is **admin**. The default password is **password**. The user name and password are case-sensitive.

4. Click the **OK** button.

The BASIC Home screen displays.

5. Select **ADVANCED > Setup > WAN Setup**.

The WAN Setup screen displays.

The screenshot shows the WAN Setup configuration page. The interface is divided into two main sections: a left sidebar and a main content area. The sidebar includes tabs for 'BASIC' and 'ADVANCED', with 'ADVANCED' selected. Under 'ADVANCED', there are sub-sections for 'Home', 'Setup Wizard', 'Setup', 'Administration', and 'Advanced Setup'. The 'Setup' section is expanded to show 'xDSL Setup', 'Internet Setup', 'Wireless Setup', 'WAN Setup' (highlighted), and 'LAN Setup'. The main content area is titled 'WAN Setup' and contains several configuration options:

- WAN Preference:** Must use DSL WAN (dropdown menu)
- Use port 2 as:** LAN (dropdown menu)
- Disable Port Scan and DoS Protection**
- Respond to Ping on Internet Port**
- Disable IGMP Proxying**
- MTU Size(in bytes):** 1492 (text input field)
- NAT Filtering:** Secured (radio button selected), Open (radio button)
- Disable SIP ALG**
- Disable FTP ALG**
- VPN Passthrough:**
 - IPSec Passthrough: Enable (radio button selected), Disable (radio button)
 - PPTP Passthrough: Enable (radio button selected), Disable (radio button)
 - L2TP Passthrough: Enable (radio button selected), Disable (radio button)

Buttons for 'Cancel' and 'Apply' are located at the top right of the configuration area.

6. To enable port scan and DoS protection, clear the **Disable Port Scan and DoS Protection** check box.

Note: Enabling port scan and DoS protection might affect the performance of the modem router.

7. To enable modem router to respond to a ping, select the **Respond to Ping on Internet Port** check box.
8. Click the **Apply** button.
Your changes are saved.

Manage IGMP Proxying and VPN Pass-Through

IGMP proxying allows a computer on the local area network (LAN) to receive the multicast traffic it is interested in from the Internet. If you do not need this feature, leave it disabled it, which is the default setting.

When Network Address Translation (NAT) is enabled in the modem router (see *Manually Set Up the Internet Connection* on page 29), it filters encrypted tunnel packets through NAT, causing these packets to become invalid. VPN pass-through allows encrypted tunnel packets to go through without being filtered and is enabled by default for IPSec, PPTP, and L2TP packets. Do not disable VPN pass-through for IPSec, PPTP, or L2TP unless a specific reason exists.

- **To change the default IGMP proxying and VPN pass-through settings:**
 1. Launch an Internet browser from a computer or WiFi device that is connected to the network.
 2. Type **http://www.routerlogin.net** or **http://www.routerlogin.com**.
A login screen displays.
 3. Enter the user name and password for the modem router.
The user name is **admin**. The default password is **password**. The user name and password are case-sensitive.
 4. Click the **OK** button.
The BASIC Home screen displays.
 5. Select **ADVANCED > Setup > WAN Setup**.
The WAN Setup screen displays.

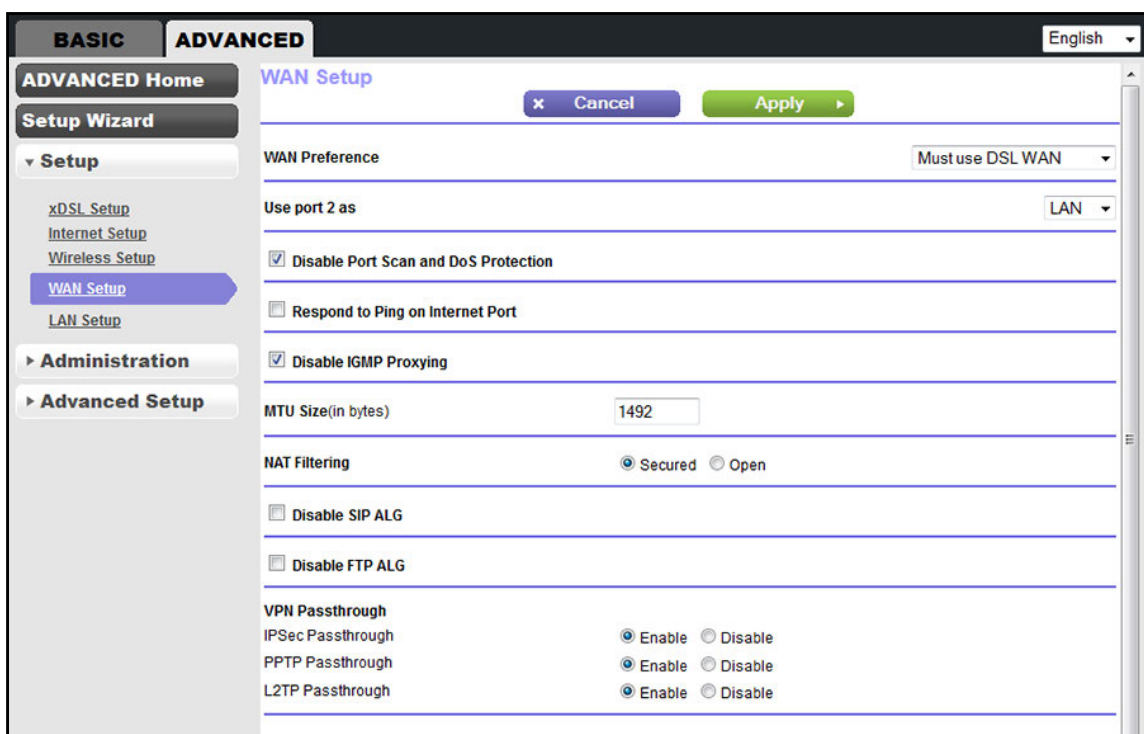

6. To enable IGMP proxying, clear the **Disable IGMP Proxying** check box.
By default, the **Disable IGMP Proxying** check box is selected and IGMP proxying is disabled.
7. To disable VPN pass-through for one or more protocols, select the corresponding **Disable** radio buttons in the VPN Passthrough section.
By default, the VPN pass-through is enabled for all protocols.
8. Click the **Apply** button.
Your changes are saved.

Manage NAT Filtering

Network Address Translation (NAT) determines how the modem router processes inbound traffic. Secured NAT protects computers on the LAN from attacks from the Internet but might prevent some Internet games, point-to-point applications, or multimedia applications from working. Open NAT provides a much less secured firewall but allows almost all Internet applications to work. Secured NAT is the default setting.

- **To change the default NAT filtering settings:**
 1. Launch an Internet browser from a computer or WiFi device that is connected to the network.
 2. Type <http://www.routerlogin.net> or <http://www.routerlogin.com>.

A login screen displays.

3. Enter the user name and password for the modem router.

The user name is **admin**. The default password is **password**. The user name and password are case-sensitive.

4. Click the **OK** button.

The BASIC Home screen displays.

5. Select **ADVANCED > Setup > WAN Setup**.

The WAN Setup screen displays.

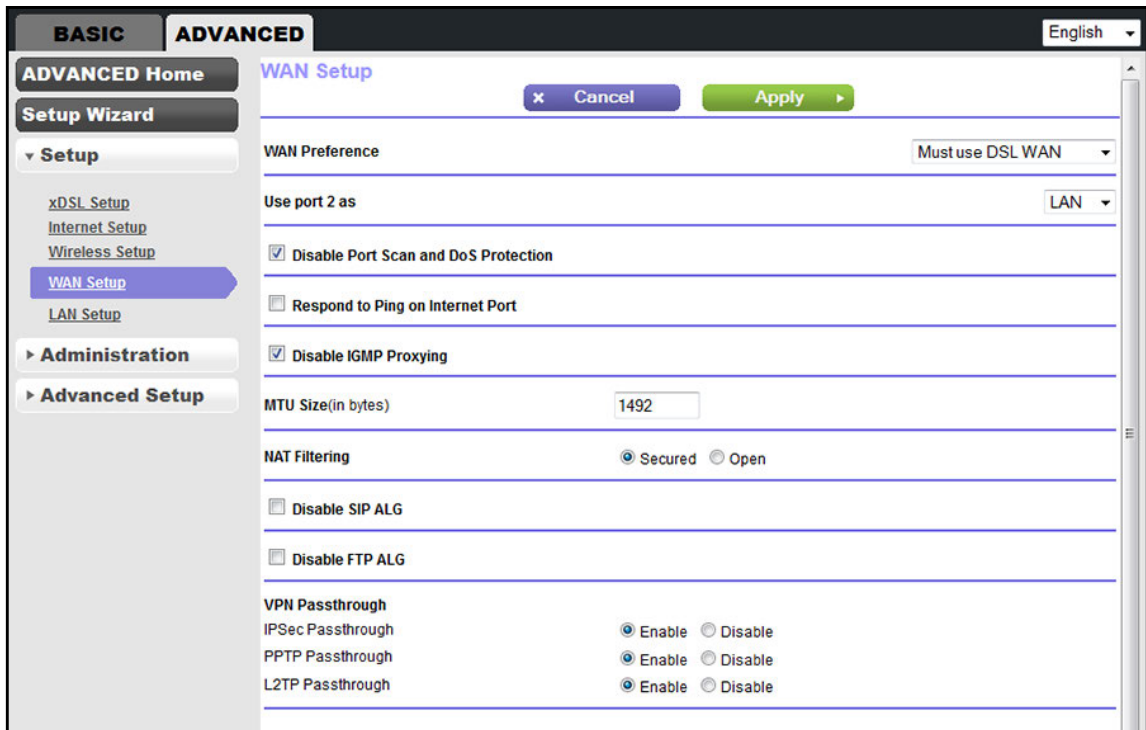

6. Select a NAT Filtering radio button:

- **Secured**. Provides a secured firewall to protect the computers on the LAN from attacks from the Internet but might prevent some Internet games, point-to-point applications, or multimedia applications from functioning. By default, the **Secured** radio button is selected.
- **Open**. Provides a much less secured firewall but allows almost all Internet applications to function.

7. Click the **Apply** button.

Your changes are saved.

Manage the Application Level Gateway

The Application Level Gateways (ALGs) for the Session Initiation Protocol (SIP) and for the File Transfer Protocol (FTP) are enabled by default for enhanced address and port translation. However, some types of VoIP and video traffic might not work well when the SIP ALG is enabled, and some types of FTP transfers might not work well when the FTP ALG is enabled. For this reason, the modem router provides the option to disable the SIP ALG and the FTP ALG.

➤ To change the default ALG settings:

1. Launch an Internet browser from a computer or WiFi device that is connected to the network.
2. Type <http://www.routerlogin.net> or <http://www.routerlogin.com>.

A login screen displays.

3. Enter the user name and password for the modem router.

The user name is **admin**. The default password is **password**. The user name and password are case-sensitive.

4. Click the **OK** button.

The BASIC Home screen displays.

5. Select **ADVANCED > Setup > WAN Setup**.

The WAN Setup screen displays.

The screenshot shows the WAN Setup configuration page. The interface is divided into a left sidebar and a main content area. The sidebar includes tabs for 'BASIC' and 'ADVANCED', and a 'Setup Wizard' section with options for 'Setup', 'Administration', and 'Advanced Setup'. The 'Setup' section is expanded to show 'xDSL Setup', 'Internet Setup', 'Wireless Setup', 'WAN Setup' (highlighted), and 'LAN Setup'. The main content area is titled 'WAN Setup' and contains several configuration options:

- WAN Preference:** A dropdown menu set to 'Must use DSL WAN'.
- Use port 2 as:** A dropdown menu set to 'LAN'.
- Disable Port Scan and DoS Protection:** A checked checkbox.
- Respond to Ping on Internet Port:** An unchecked checkbox.
- Disable IGMP Proxying:** A checked checkbox.
- MTU Size(in bytes):** A text input field containing '1492'.
- NAT Filtering:** Radio buttons for 'Secured' (selected) and 'Open'.
- Disable SIP ALG:** An unchecked checkbox.
- Disable FTP ALG:** An unchecked checkbox.
- VPN Passthrough:** Radio buttons for 'Enable' and 'Disable' for three protocols:
 - IPSec Passthrough: Enable (selected), Disable
 - PPTP Passthrough: Enable (selected), Disable
 - L2TP Passthrough: Enable (selected), Disable

At the top right of the main content area, there are 'Cancel' and 'Apply' buttons. The language is set to 'English' in the top right corner.

6. To disable the SIP ALG, select the **Disable SIP ALG** check box.
The SIP ALG is enabled by default.
7. To disable the FTP ALG, select the **Disable FTP ALG** check box.
The FTP ALG is enabled by default.
8. Click the **Apply** button.
Your changes are saved.

Manage the Modem Router's LAN IP Address

The modem router is preconfigured to use private IP addresses on the LAN side and to act as a DHCP server. The modem router's default LAN IP configuration is as follows:

- **LAN IP address.** 192.168.1.1
- **Subnet mask.** 255.255.255.0

These addresses are part of the designated private address range for use in private networks and are suitable for most applications. The IP address and subnet mask identify which addresses are local to a specific device and which must be reached through a gateway or router. You might want to change these settings if you need a specific IP subnet that one or more devices on the network uses, or if competing subnets use the same IP scheme.

➤ To change the LAN TCP/IP settings:

1. Launch an Internet browser from a computer or WiFi device that is connected to the network.
2. Type **http://www.routerlogin.net** or **http://www.routerlogin.com**.
A login screen displays.
3. Enter the user name and password for the modem router.
The user name is **admin**. The default password is **password**. The user name and password are case-sensitive.
4. Click the **OK** button.
The BASIC Home screen displays.
5. Select **ADVANCED > Setup > LAN Setup**.
The LAN Setup screen displays.

6. In the **IP Address** field, type the LAN IP address for the modem router.
7. In the **IP Subnet Mask**, type the LAN subnet mask for the modem router.
8. Click the **Apply** button.

Your changes are saved.

If you changed the LAN IP address of the modem router, you are disconnected when the changes take effect.

To reconnect, close your browser, relaunch it, and log in to the router.

Change the Modem Router's Device Name

The router's device name is D500 or D1500, depending on the model of the modem router. This device name displays in a file manager when you browse your network.

➤ To change the router's device name:

1. Launch an Internet browser from a computer or WiFi device that is connected to the network.
2. Type <http://www.routerlogin.net> or <http://www.routerlogin.com>.

A login screen displays.

3. Enter the user name and password for the modem router.

The user name is **admin**. The default password is **password**. The user name and password are case-sensitive.

4. Click the **OK** button.

The BASIC Home screen displays.

5. Select **ADVANCED > Setup > LAN Setup**.

The LAN Setup screen displays.

6. In the **Device Name** field, type a new name.

7. Click the **Apply** button.

Your change is saved.

Manage the DHCP Server Address Pool

By default, the modem router acts as a Dynamic Host Configuration Protocol (DHCP) server. The router assigns IP, DNS server, and default gateway addresses to all computers that are connected to its LAN and WiFi network. The assigned default gateway address is the LAN address of the modem router.

These addresses must be part of the same IP address subnet as the modem router's LAN IP address. The default DHCP address pool is 192.168.1.2–192.168.1.254.

The modem router delivers the following parameters to any LAN device that requests DHCP:

- An IP address from the range that you define
- Subnet mask
- Gateway IP address (the modem router's LAN IP address)
- DNS server IP address (the modem router's LAN IP address)

➤ To specify the pool of IP addresses that the router assigns:

1. Launch an Internet browser from a computer or WiFi device that is connected to the network.
2. Type **http://www.routerlogin.net** or **http://www.routerlogin.com**.
A login screen displays.
3. Enter the user name and password for the modem router.
The user name is **admin**. The default password is **password**. The user name and password are case-sensitive.
4. Click the **OK** button.
The BASIC Home screen displays.
5. Select **ADVANCED > Setup > LAN Setup**.
The LAN Setup screen displays.

The screenshot shows the 'LAN Setup' configuration page. The 'Device Name' is set to 'D1500'. Under 'LAN TCP/IP Setup', the IP Address is '192.168.1.1' and the IP Subnet Mask is '255.255.255.0'. The 'Use Router as DHCP Server' checkbox is checked. The 'Starting IP Address' is '192.168.1.2' and the 'Ending IP Address' is '192.168.1.254'. There are 'Cancel' and 'Apply' buttons at the top right.

6. Make sure that the **Use Router as DHCP Server** check box is selected.
This check box is selected by default.
7. Specify the range of IP addresses that the router assigns:
 - a. In the **Starting IP Address** field, type the lowest number in the range.
This IP address must be in the same subnet as the modem router. By default, the starting IP address is 192.168.1.2.
 - b. In the **Ending IP Address** field, type the number at the end of the range of IP addresses.
This IP address must be in the same subnet as the modem router. By default, the ending IP address is 192.168.1.254.
8. Click the **Apply** button.
Your settings are saved.

Disable the Built-In DHCP Server

By default, the modem router functions as a DHCP server. The router assigns IP, DNS server, and default gateway addresses to all computers connected to the LAN. The assigned default gateway address is the LAN address of the modem router.

You can use another device on your network as the DHCP server or specify the network settings of all your computers.

- **To disable the built-in DHCP server:**
 1. Launch an Internet browser from a computer or WiFi device that is connected to the network.
 2. Type <http://www.routerlogin.net> or <http://www.routerlogin.com>.
A login screen displays.
 3. Enter the user name and password for the modem router.

The user name is **admin**. The default password is **password**. The user name and password are case-sensitive.

4. Click the **OK** button.

The BASIC Home screen displays.

5. Select **ADVANCED > Setup > LAN Setup**.

The LAN Setup screen displays.

6. Clear the **Use Router as DHCP Server** check box.

7. Click the **Apply** button.

Your settings are saved.

8. (Optional) If you disable the DHCP server and no other DHCP server is available on your network, set your computer IP addresses manually so that they can access the modem router.

Set Up and Manage Static Routes

Static routes provide detailed routing information to your modem router. Typically, you do not need to add static routes. You must configure static routes only for unusual cases such as multiple modem routers or multiple IP subnets on your network.

As an example of when a static route is needed, consider the following case:

- Your primary Internet access is through an ADSL modem to an ISP.
- You use an ISDN router on your home network for connecting to the company where you are employed. This router's address on your LAN is 192.168.0.100.
- Your company's network address is 134.177.0.0.

When you first configured your modem router, two implicit static routes were created. A default route was created with your ISP as the gateway and a second static route was created to your local network for all 192.168.0.x addresses. With this configuration, if you attempt to access a device on the 134.177.0.0 network, your modem router forwards your request to the ISP. The ISP forwards your request to the company where you are employed, and the request is likely to be denied by the company's firewall.

In this case, you must define a static route, instructing your modem router that 134.177.0.0 is accessed through the ISDN modem router at 192.168.0.100. Here is an example:

- Through the destination IP address and IP subnet mask, specify that this static route applies to all 134.177.x.x addresses.
- Through the gateway IP address, specify that all traffic for these addresses is forwarded to the ISDN modem router at 192.168.0.100.
- A metric value of 1 works fine because the ISDN modem router is on the LAN.

Set Up a Static Route

You can add a static route to a destination IP address and specify the subnet mask, gateway IP address, and metric.

➤ **To set up a static route:**

1. Launch an Internet browser from a computer or WiFi device that is connected to the network.
2. Type <http://www.routerlogin.net> or <http://www.routerlogin.com>.

A login screen displays.

3. Enter the user name and password for the modem router.

The user name is **admin**. The default password is **password**. The user name and password are case-sensitive.

4. Click the **OK** button.

The BASIC Home screen displays.

5. Select **ADVANCED > Advanced Setup > Static Routes**.

The Static Routes screen displays.

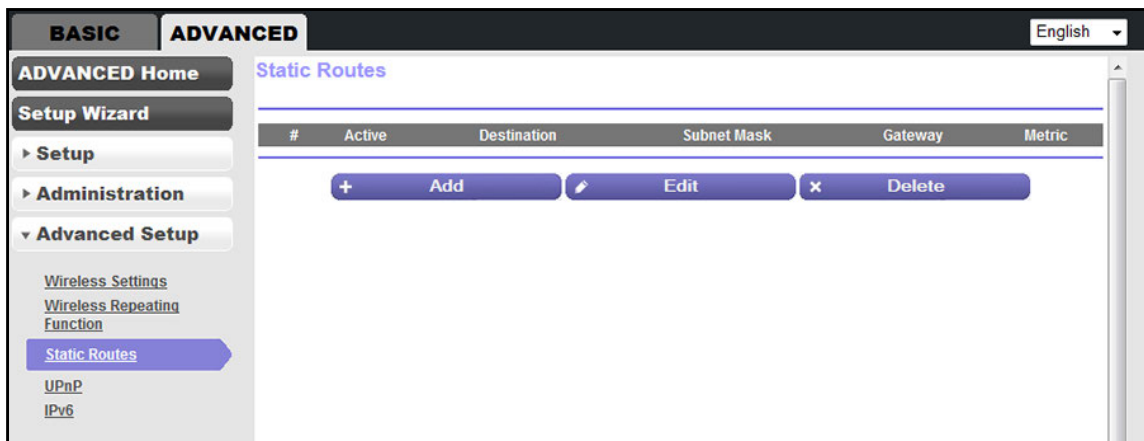

6. Click the **Add** button.

The screen adjusts.

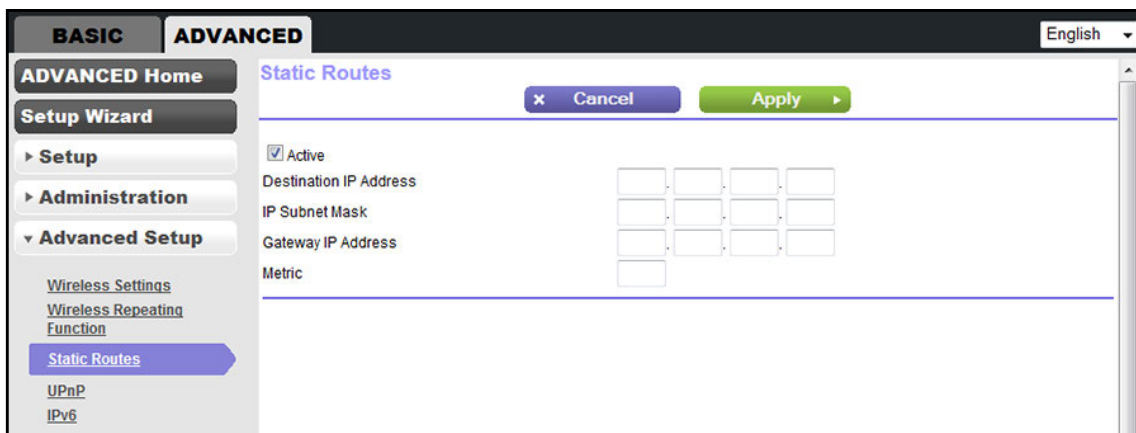

7. To prevent the route from becoming active after you click the **Apply** button, clear the **Active** check box.

In some situations, you might want to set up a static route but keep it disabled until a later time. By default, the **Active** check box is selected and a route becomes active after you click the **Apply** button.

8. Enter the settings that are described in the following table.

Field	Description
Destination IP Address	Enter the IP address for the final destination of the route.
IP Subnet Mask	Enter the IP subnet mask for the final destination of the route. If the destination is a single host, type 255.255.255.255 .
Gateway IP Address	Enter the IP address of the gateway. The IP address of the gateway must be on the same LAN segment as the modem router.
Metric	Enter a number from 1 through 15. This value represents the number of routers between your network and the destination. Usually, a setting of 2 or 3 works, but if this is a direct connection, set it to 1 .

9. Click the **Apply** button.

Your settings are saved and the static route is added to the table on the Static Route screen.

Change a Static Route

You can change an existing static route.

➤ **To change a static route:**

1. Launch an Internet browser from a computer or WiFi device that is connected to the network.
2. Type **http://www.routerlogin.net** or **http://www.routerlogin.com**.
A login screen displays.
3. Enter the user name and password for the modem router.
The user name is **admin**. The default password is **password**. The user name and password are case-sensitive.
4. Click the **OK** button.
The BASIC Home screen displays.
5. Select **ADVANCED > Advanced Setup > Static Routes**.
The Static Routes screen displays.
6. In the Static Routes table, select the radio button to the left of the route that you want to change.
7. Click the **Edit** button.
The screen adjusts.
8. Change the settings for the route.
For more information about the settings, see [Set Up a Static Route](#) on page 76.
9. Click the **Apply** button.
The route is updated in the table on the Static Routes screen.

Remove a Static Route

You can remove an existing static route that you no longer need.

➤ **To remove a static route:**

1. Launch an Internet browser from a computer or WiFi device that is connected to the network.
2. Type **http://www.routerlogin.net** or **http://www.routerlogin.com**.
A login screen displays.
3. Enter the user name and password for the modem router.
The user name is **admin**. The default password is **password**. The user name and password are case-sensitive.

4. Click the **OK** button.
The BASIC Home screen displays.
5. Select **ADVANCED > Advanced Setup > Static Routes**.
The Static Routes screen displays.
6. In the Static Routes table, select the radio button to the left of the route that you want to remove.
7. Click the **Delete** button.
The route is removed from the table on the Static Routes screen.

Manage Universal Plug and Play

Universal Plug and Play (UPnP) enables devices, such as Internet devices and computers, to access the network and connect to other devices as needed. UPnP devices can automatically discover the services from other registered UPnP devices on the network.

If you use applications such as multiplayer gaming, peer-to-peer connections, or real-time communications such as instant messaging or remote assistance, NETGEAR recommends that you keep UPnP enabled, which is the default setting.

To manage Universal Plug and Play:

1. Launch an Internet browser from a computer or WiFi device that is connected to the network.
2. Type **http://www.routerlogin.net** or **http://www.routerlogin.com**.
A login screen displays.
3. Enter the user name and password for the modem router.
The user name is **admin**. The default password is **password**. The user name and password are case-sensitive.
4. Click the **OK** button.
The BASIC Home screen displays.
5. Select **ADVANCED > Advanced Setup > UPnP**.
The UPnP screen displays.

The screenshot shows the 'UPnP' configuration page in the router's web interface. The 'Turn UPnP On' checkbox is checked. The 'UPnP Portmap Table' is displayed below, showing the following data:

Active	Protocol	Int. Port	Ext. Port	IP Address
Yes	UDP	62613	62613	192.168.100.111
Yes	UDP	52280	52280	192.168.100.111
Yes	UDP	56463	56463	192.168.100.111

The UPnP Portmap Table displays the IP address of each UPnP device that is accessing the modem router and which internal and external ports that device opened. The UPnP Portmap Table also displays what type of port (that is, the protocol that is associated with port) is open and whether that port is still active for each IP address.

6. To turn off UPnP, clear the **Turn UPnP On** check box.

By default, this check box is selected. If you clear the Turn UPnP On check box, the modem router does not allow any device to automatically control the resources of the modem router.

7. Click the **Apply** button.

Your settings are saved.

8. To refresh the information in the UPnP Portmap Table, click the **Refresh** button.

The information onscreen is updated.

6

6 Manage the Modem Router and Monitor the Traffic

This chapter describes how you can manage the settings for administering and maintaining your modem router and monitor the network.

The chapter includes the following sections:

- *Update the Firmware of the Modem Router*
- *Manage the Configuration File of the Modem Router*
- *Return the Modem Router to Its Factory Default Settings*
- *View the Status and Statistics of the Modem Router*
- *View Devices Currently on the Network*

Note: For information about changing the admin password, see *Change the admin Password and Automatic Login Time-Out* on page 24.

Update the Firmware of the Modem Router

The modem router firmware is stored in flash memory.

You can check to see if new firmware is available and update the modem router to the new firmware. You can also visit the NETGEAR support website, download the firmware manually, and update the modem router to the new firmware.

Automatically Check for New Firmware and Update the Modem Router

For you to check for new firmware, the modem router must be connected to the Internet.

➤ **To check for new firmware and update your modem router:**

1. Launch an Internet browser from a computer or WiFi device that is connected to the network.
2. Type <http://www.routerlogin.net> or <http://www.routerlogin.com>.

A login screen displays.

3. Enter the user name and password for the modem router.

The user name is **admin**. The default password is **password**. The user name and password are case-sensitive.

4. Click the **OK** button.

The BASIC Home screen displays.

5. Select **ADVANCED > Administration > Firmware Update**.

The Firmware Update screen displays.

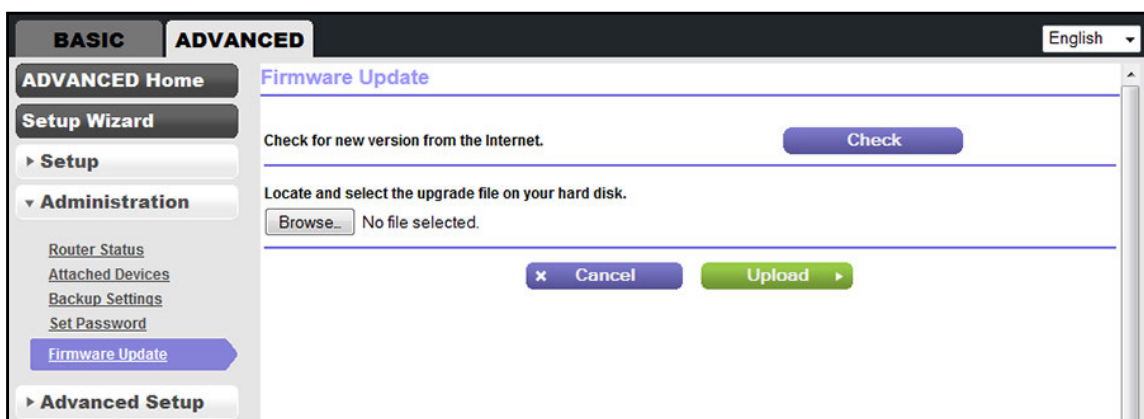

6. Click the **Check** button.

If new firmware is available, the modem router finds and downloads the firmware.

7. Click the **Yes** button.

The modem router locates the firmware that was downloaded and begins the update.



WARNING:

To avoid the risk of corrupting the firmware, do not interrupt the upload. For example, do not close the browser, click a link, or load a new page. Do not turn off the modem router.

A progress bar shows the progress of the firmware upload process. The firmware upload process takes several minutes. When the upload is complete, your modem router restarts.

8. Verify that the modem router runs the new firmware version:
 - a. Launch an Internet browser from a computer or WiFi device that is connected to the network.
 - b. Type **<http://www.routerlogin.net>** or **<http://www.routerlogin.com>**.
A login screen displays.
 - c. Enter the user name and password for the modem router.
The user name is **admin**. The default password is **password**. The user name and password are case-sensitive.
 - d. Click the **OK** button.
The BASIC Home screen displays.

The firmware version is stated in the top right, under the **Logout** button.

Manually Check for New Firmware and Update the Modem Router

Downloading firmware and updating the modem router are two separate tasks that are combined in the following procedure.

- **To download new firmware manually and update your modem router:**
 1. Visit downloadcenter.netgear.com, locate the support page for your product, and download the new firmware.
 2. Read the new firmware release notes to determine whether you must reconfigure the modem router after updating.
 3. Launch an Internet browser from a computer or WiFi device that is connected to the network.
 4. Type **<http://www.routerlogin.net>** or **<http://www.routerlogin.com>**.
A login screen displays.
 5. Enter the user name and password for the modem router.

The user name is **admin**. The default password is **password**. The user name and password are case-sensitive.

6. Click the **OK** button.

The BASIC Home screen displays.

7. Select **ADVANCED > Administration > Firmware Update**.

The Firmware Update screen displays.

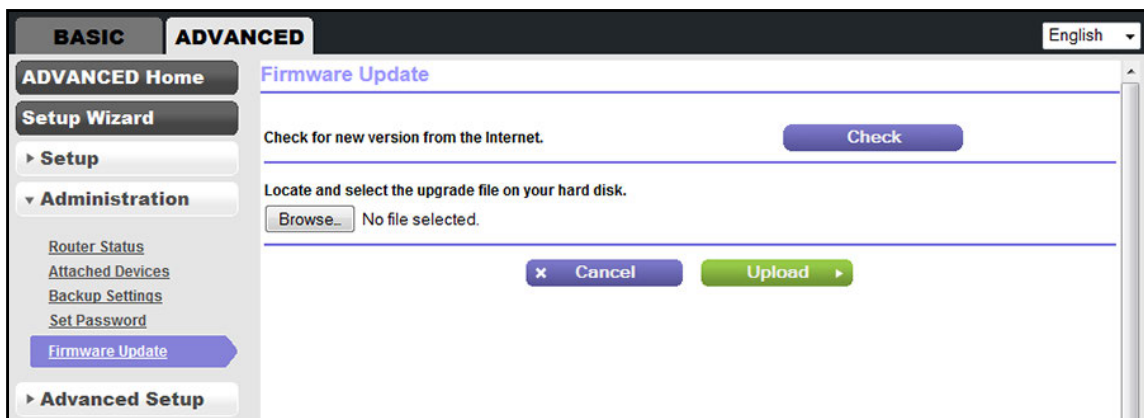

8. Locate and select the firmware file on your computer:

- a. Click the **Browse** button.
- b. Navigate to the firmware file.

The file ends in `.img`. An example of a firmware file name is `D1500-V1.0.0.14_1.0.1PE.img`.

- c. Select the firmware file.

9. Click the **Upload** button.



WARNING:

To avoid the risk of corrupting the firmware, do not interrupt the upload. For example, do not close the browser, click a link, or load a new page. Do not turn off the modem router.

A progress bar shows the progress of the firmware upload process. The firmware upload process takes several minutes. When the upload is complete, your modem router restarts.

10. Verify that the modem router runs the new firmware version:

- a. Launch an Internet browser from a computer or WiFi device that is connected to the network.
- b. Type **`http://www.routerlogin.net`** or **`http://www.routerlogin.com`**.

A login screen displays.

- c. Enter the user name and password for the modem router.

The user name is **admin**. The default password is **password**. The user name and password are case-sensitive.

- d. Click the **OK** button.

The BASIC Home screen displays.

The version firmware is stated in the top right, under the **Logout** button.

Manage the Configuration File of the Modem Router

The configuration settings of the modem router are stored within the modem router in a configuration file. You can back up (save) this file to your computer or restore it.

Back Up the Settings

You can save a copy of the current configuration settings.

- **To back up the modem router’s configuration settings:**

1. Launch an Internet browser from a computer or WiFi device that is connected to the network.
2. Type <http://www.routerlogin.net> or <http://www.routerlogin.com>.

A login screen displays.

3. Enter the user name and password for the modem router.

The user name is **admin**. The default password is **password**. The user name and password are case-sensitive.

4. Click the **OK** button.

The BASIC Home screen displays.

5. Select **ADVANCED > Administration > Backup Settings**.

The Backup Settings screen displays.

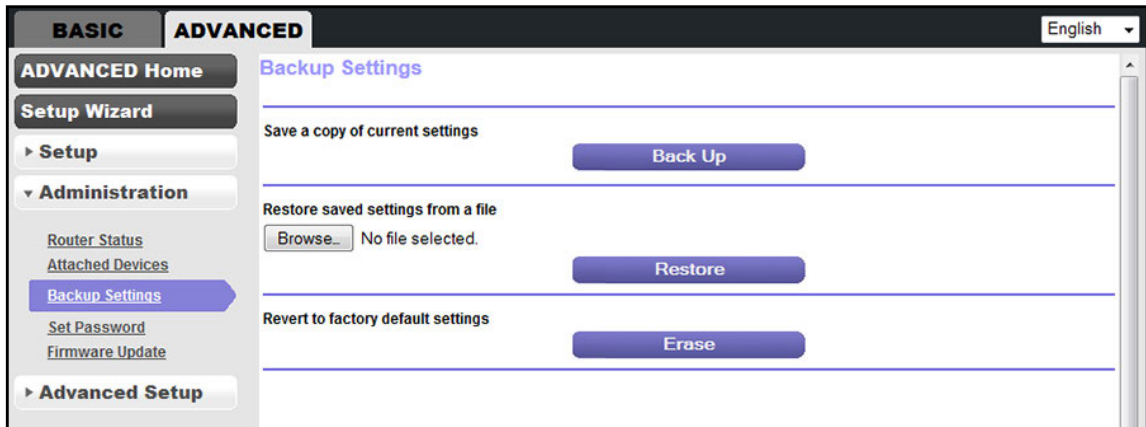

6. Click the **Back Up** button.
7. Choose a location to store the file on your computer.
The name of the backup file is `NETGEAR_D500.cfg` or `NETGEAR_D500.cfg`.
8. Follow the directions of your browser to save the file.

Restore the Settings

If you backed up the configuration file, you can restore the configuration from this file.

➤ To restore configuration settings that you backed up:

1. Launch an Internet browser from a computer or WiFi device that is connected to the network.
2. Type <http://www.routerlogin.net> or <http://www.routerlogin.com>.
A login screen displays.
3. Enter the user name and password for the modem router.
The user name is **admin**. The default password is **password**. The user name and password are case-sensitive.
4. Click the **OK** button.
The BASIC Home screen displays.
5. Select **ADVANCED > Administration > Backup Settings**.
The Backup Settings screen displays.

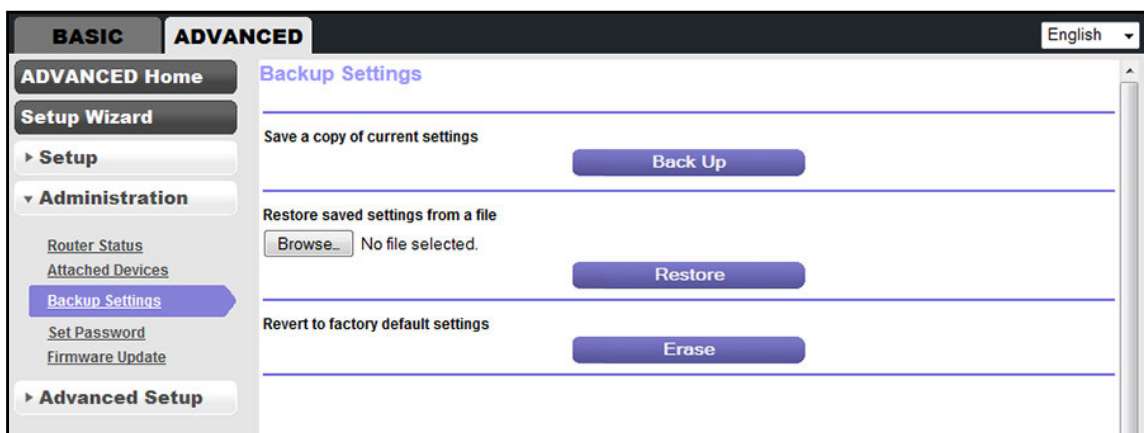

6. Click the **Browse** button and navigate to and select the saved configuration file.
The name of the backup file from which you can restore the configuration is `NETGEAR_D500.cfg` or `NETGEAR_D500.cfg`.
Follow the directions of your browser to locate and select the file.
7. Click the **Restore** button.

The configuration is uploaded to the modem router. When the restoration is complete, the modem router reboots. This process takes about one minute.



WARNING:

To avoid the risk of corrupting the firmware, do not interrupt the restoration. For example, do not close the browser, click a link, or load a new page. Do not turn off the modem router.

Return the Modem Router to Its Factory Default Settings

Under some circumstances (for example, if you lost track of the changes that you made to the modem router settings or you move the modem router to a different network), you might want to erase the configuration and reset it to factory default settings.

If you do not know the current IP address of the modem router, first try to use an IP scanner application to detect the IP address before you reset the modem router to factory default settings.

To reset the modem router to factory default settings, you can use either the **Reset** button on the back of the modem router or the Erase function. However, if you cannot find the IP address or lost the password to access the modem router, you must use the **Reset** button.

After you reset the modem router to factory default settings, the user name is admin, the password is password, the LAN IP address is 192.168.0.1 (which is the same as www.routerlogin.net), and the DHCP server is enabled. For a list of factory default settings, see [Factory Settings](#) on page 112.

Use the Reset Button



CAUTION:

This process erases all settings that you configured in the modem router.

➤ **To reset the modem router to factory default settings:**

1. On the back of the modem router, locate the **Reset** button.

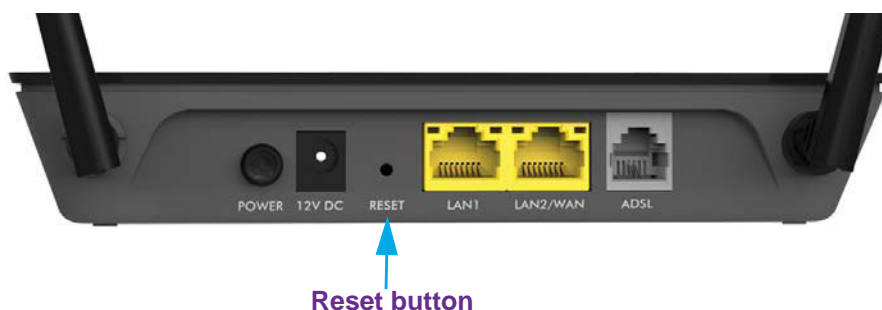

2. Using a straightened paper clip, press and hold the **Reset** button for eight seconds.
3. Release the **Reset** button.

The configuration is reset to factory default settings. When the reset is complete, the modem router reboots. This process takes about one minute.



WARNING:

To avoid the risk of corrupting the firmware, do not interrupt the reset. For example, if you are connected to the web management interface, do not close the browser, click a link, or load a new page. Do not turn off the modem router.

Erase the Settings



CAUTION:

This process erases all settings that you configured in the modem router.

➤ **To erase the settings:**

1. Launch an Internet browser from a computer or WiFi device that is connected to the network.
2. Type **http://www.routerlogin.net** or **http://www.routerlogin.com**.
A login screen displays.
3. Enter the user name and password for the modem router.
The user name is **admin**. The default password is **password**. The user name and password are case-sensitive.
4. Click the **OK** button.
The BASIC Home screen displays.
5. Select **ADVANCED > Administration > Backup Settings**.
The Backup Settings screen displays.

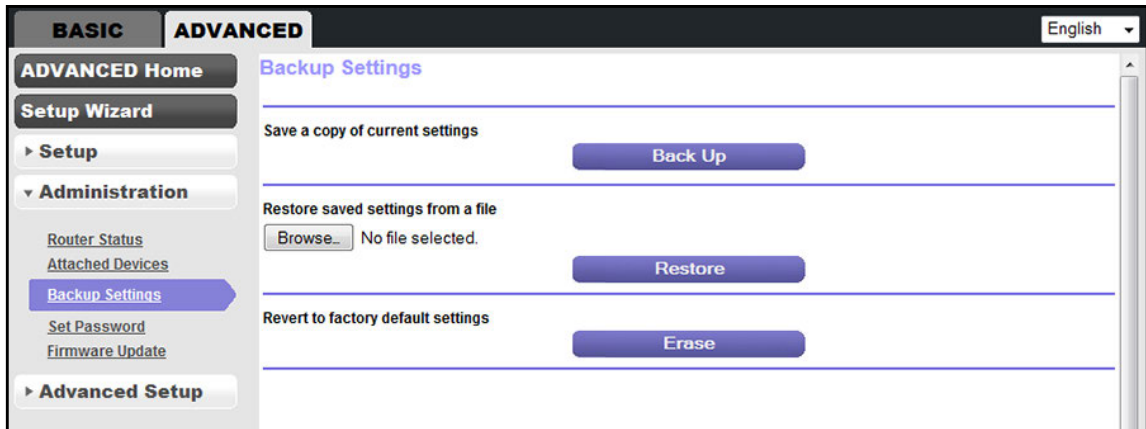

6. Click the **Erase** button.

The configuration is reset to factory default settings. When the reset is complete, the modem router reboots. This process takes about one minute.



WARNING:

To avoid the risk of corrupting the firmware, do not interrupt the reset. For example, do not close the browser, click a link, or load a new page. Do not turn off the modem router.

View the Status and Statistics of the Modem Router

You can view information about the modem router, its broadband modem, and ports, and the status of the Internet connection and WiFi network. In addition, you can view traffic statistics for the various ports.

View Information About the Modem Router and the Internet, Modem, and WiFi Settings

The ADVANCED Home screen displays router information, the Internet port status, and WiFi settings.

- **To view information about the modem router and the Internet, modem, and WiFi settings:**
 1. Launch an Internet browser from a computer or WiFi device that is connected to the network.
 2. Type <http://www.routerlogin.net> or <http://www.routerlogin.com>.
A login screen displays.
 3. Enter the user name and password for the modem router.

The user name is **admin**. The default password is **password**. The user name and password are case-sensitive.

4. Click the **OK** button.

The BASIC Home screen displays.

5. Select **ADVANCED > ADVANCED Home**.

The ADVANCED Home screen displays.

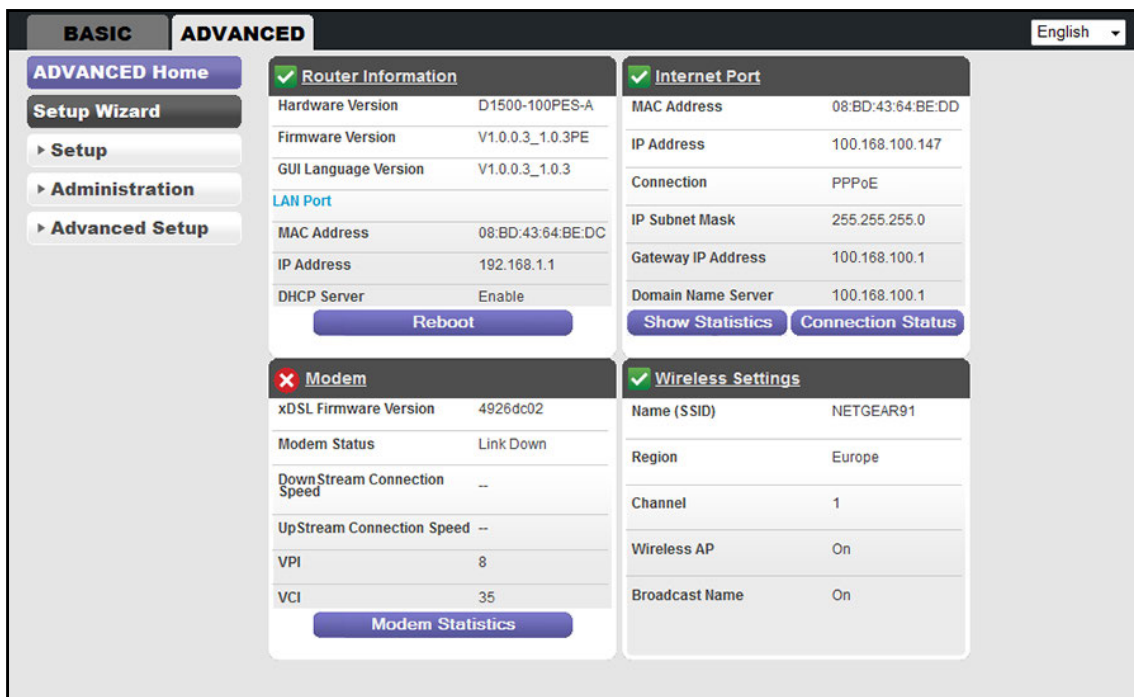

The following table describes the fields of the four panes on the ADVANCED Home screen.

Field	Description
Router Information	
Hardware Version	The modem router model.
Firmware Version	The version of the router firmware. If you upgrade the router firmware on the modem router, the version changes.
GUI Language Version	The version of the router firmware. If you upgrade the router firmware on modem router, the version changes.
LAN Port The settings of the LAN port. For information about how to configure the LAN settings, see Manage the Modem Router's LAN IP Address on page 71 and Disable the Built-In DHCP Server on page 74.	
MAC Address	The Media Access Control (MAC) address. This address is the unique physical address that is assigned to the Ethernet LAN port.

N150 and N300 WiFi DSL Modem Routers

Field	Description
IP Address	The IP address that the Ethernet LAN port uses. The default IP address is 192.168.0.1.
DHCP	Displays whether the DHCP server of the modem router is enabled for devices that are attached to the LAN.
Internet Port The settings of Internet port. The Internet connection can run through the ADSL port with DSL service or through the WAN Ethernet port with cable or fiber service. For information about how to configure the Internet settings, see one of the following sections: <ul style="list-style-type: none"> • Set Up Your Modem Router for DSL Service on page 15 • Set Up Your Modem Router for Cable or Fiber Service on page 18 • Manually Set Up the Internet Connection on page 29. 	
MAC Address	The Media Access Control (MAC) address. This address is the unique physical address that is assigned to the Internet port.
IP Address	The IP address that the Internet port uses. If this field does not display an address or displays 0.0.0.0 as the address, the modem router is not connected to the Internet.
Connection	The type of Internet connection, which can be a PPPoE connection, PPPoA connection, fixed IP address connection, or DHCP connection.
IP Subnet Mask	The IP subnet mask that the Internet port uses.
Gateway IP Address	The IP address of the gateway that the Internet port uses.
Domain Name Server	The IP address of the Domain Name System (DNS) server that the Internet uses.
Modem The setting of the xDSL modem. For information about how to configure the ADSL settings, see Manage the ADSL Settings on page 63.	
xDSL Firmware Version	The firmware version is displayed for information only. You cannot manage the xDSL firmware.
Modem Status	The status of the xDSL modem, which can be Link Up or Link Down.
DownStream Connection Speed	The downstream xDSL connection speed that the modem router detected.
UpStream Connection Speed	The upstream xDSL connection speed that the modem router detected.
VPI	The VPI that you configured or the default VPI, which is 8.
VCI	The VCI that you configured or the default VCI, which is 35.
Wireless Settings The settings of the WiFi port. For information about how to configure the WiFi settings, see Manage the Basic WiFi Settings and WiFi Security on page 49, Manage the WiFi Radio on page 56, and Manage Advanced WiFi Features on page 58.	
Name (SSID)	The WiFi network name of the WiFi network of the modem router.

Field	Description
Region	The location (country).
Channel	The channel that the WiFi network of the modem router uses.
Wireless AP	Displays whether the WiFi radio of the modem router is enabled. If the radio is disabled, the WiFi LED on the front of the modem router is off.
Broadcast Name	Displays whether the WiFi radio of the modem router broadcasts its SSID.

View the Traffic Statistics

You can view the traffic statistics for the ports of the modem router, change the polling frequency, and stop traffic polling.

➤ **To view the traffic statistics for the ports of the modem router:**

1. Launch an Internet browser from a computer or WiFi device that is connected to the network.
2. Type **http://www.routerlogin.net** or **http://www.routerlogin.com**.

A login screen displays.

3. Enter the user name and password for the modem router.

The user name is **admin**. The default password is **password**. The user name and password are case-sensitive.

4. Click the **OK** button.

The BASIC Home screen displays.

5. Select **ADVANCED > ADVANCED Home**.

The ADVANCED Home screen displays.

6. In the Internet Port pane, click the **Show Statistics** button.

A pop-up screen displays.

System Up Time 1 17:9:22						
Port	Status	TxPkts	RxPkts	Tx err	Rx err	Up Time
LAN1	Link down	0	0	0	0	0 0:0:0
LAN2	Link down	0	0	0	0	0 0:0:0
WLAN	Link up	86460	84166	56	0	0 5:5:49
WAN	Link down	0	0	0	0	0 0:0:0

Poll Interval: (secs)

The following table describes the fields and columns of the Show Statistics pop-up screen.

Field or Column	Description
System Up Time	The time elapsed since the modem router was last restarted.
Port	The statistics for the LAN (Ethernet) ports, WLAN (WiFi) port, and WAN port (that is, the ADSL or Ethernet port that connects to the Internet). For each port, the screen displays the information that is described in this table.
Status	The link status of the port.
TxPkts	The number of packets transmitted on this port since reset or manual clear.
RxPkts	The number of packets received on this port since reset or manual clear.
Tx err	The number of packets with an error transmitted on this port since reset or manual clear.
Rx err	The number of packets with an error received on this port since reset or manual clear.
Up Time	The time elapsed since this port acquired the link.
Poll Interval	The interval at which the statistics are updated in this screen.

➤ **To change the traffic statistics polling frequency or stop polling:**

1. Launch an Internet browser from a computer or WiFi device that is connected to the network.
2. Type **http://www.routerlogin.net** or **http://www.routerlogin.com**.
A login screen displays.
3. Enter the user name and password for the modem router.
The user name is **admin**. The default password is **password**. The user name and password are case-sensitive.
4. Click the **OK** button.
The BASIC Home screen displays.
5. Select **ADVANCED > ADVANCED Home**.
The ADVANCED Home screen displays.
6. In the Internet Port pane, click the **Show Statistics** button.
A pop-up screen displays.
7. Change the polling frequency or stop polling:
 - To change the polling frequency:
 - a. In the **Poll Interval** field, enter a time in seconds.
 - b. Click the **Set Interval** button.
 - To stop polling, click the **Stop** button.

View or Change a PPPoE or PPPoA Internet Connection

You can view information about a PPPoE or PPPoA Internet connection of the modem router and establish or terminate such a connection.

➤ **To view or change the PPPoE or PPPoA Internet connection status:**

1. Launch an Internet browser from a computer or WiFi device that is connected to the network.
2. Type **http://www.routerlogin.net** or **http://www.routerlogin.com**.

A login screen displays.

3. Enter the user name and password for the modem router.

The user name is **admin**. The default password is **password**. The user name and password are case-sensitive.

4. Click the **OK** button.

The BASIC Home screen displays.

5. Select **ADVANCED > ADVANCED Home**.

The ADVANCED Home screen displays.

6. In the Internet Port pane, click the **Connection Status** button.

The Connection Status pop-up screen displays. The fields that display depend on the type of Internet connection.

The following screen shows an established PPPoE connection.

Connection Status	
Connection Time	00:03:45
Connection Status	connected
Negotiation	Success
Authentication	Success
IP Address	192.168.250.39
Subnet Mask	255.255.255.255
<input type="button" value="Connect"/> <input type="button" value="Disconnect"/>	
<input type="button" value="Close Window"/>	

The following table describes the fields of the Connection Status pop-up screen.

Field	Description
Connection Time	The time elapsed since the connection was established.
Connection Status	The status can be Connected or Disconnected.

Field	Description
Negotiation	The negotiation can be a series of dashes, which indicates that the connection is not established, or successful (Success).
Authentication	The authentication can be a series of dashes, which indicates that the connection is not established, or successful (Success).
IP Address	The IP address that is assigned by the ISP to the modem router.
Subnet Mask	The subnet mask that is assigned by the ISP to the modem router.

7. To establish the Internet connection when the connection is down, click the **Connect** button.
8. To terminate the Internet connection when the connection is active, click the **Disconnect** button.
9. Click the **Close Window** button.
The pop-up screen closes.

View or Change a TCP/IP Internet Connection

You can view information about a TCP/IP Internet connection of the modem router and renew or release such a connection.

➤ To view or change the TCP/IP Internet connection status:

1. Launch an Internet browser from a computer or WiFi device that is connected to the network.
2. Type **http://www.routerlogin.net** or **http://www.routerlogin.com**.
A login screen displays.
3. Enter the user name and password for the modem router.
The user name is **admin**. The default password is **password**. The user name and password are case-sensitive.
4. Click the **OK** button.
The BASIC Home screen displays.
5. Select **ADVANCED > ADVANCED Home**.
The ADVANCED Home screen displays.
6. In the Internet Port pane, click the **Connection Status** button.
The Connection Status pop-up screen displays. The fields that display depend on the type of Internet connection.
The following screen shows the fields for an established TCP/IP connection with DHCP.

Connection Status	
IP Address	100.168.100.147
Subnet Mask	255.255.255.0
Default Gateway	100.168.100.1
DHCP Server	100.168.100.1
DNS Server	100.168.100.1 0.0.0.0
<input type="button" value="Release"/> <input type="button" value="Renew"/>	
<input type="button" value="Close Window"/>	

The following table describes the fields of the Connection Status pop-up screen.

Field	Description
IP Address	The IP address that is assigned by the ISP to the modem router.
Subnet Mask	The subnet mask that is assigned by the ISP to the modem router.
Default Gateway	The IP address of the default gateway of the ISP that the modem router communicates with.
DHCP Server	The IP address of the DHCP server of the ISP that issues the IP address to the modem router.
DNS Server	The IP address of the Domain Name System (DNS) server of the ISP that provides translation of network names to IP addresses.

7. To renew the Internet connection when the connection is active, click the **Renew** button.
8. To terminate the Internet connection when the connection is active, click the **Release** button.
9. Click the **Close Window** button.

The pop-up screen closes.

View the xDSL Line Status and Modem Statistics

The xDSL Line Status screen displays the xDSL line status and modem statistics. You cannot change these settings.

➤ To view modem router status:

1. Launch an Internet browser from a computer or WiFi device that is connected to the network.
2. Type **http://www.routerlogin.net** or **http://www.routerlogin.com**.
A login screen displays.
3. Enter the user name and password for the modem router.

The user name is **admin**. The default password is **password**. The user name and password are case-sensitive.

4. Click the **OK** button.

The BASIC Home screen displays.

5. Select **ADVANCED > ADVANCED Home**.

The ADVANCED Home screen displays.

6. In the Modem pane, click the **Modem Statistics** button.

The xDSL Line Status pop-up screen displays.

xDSL Line Status		
Mode	--	
Latency	--	
Trellis Coding	1	
Status	ACTIVATING.	
Power Level	L0	
Uptime	--	
	Downstream	Upstream
SNR Margin (dB)	--	--
Attenuation (dB)	--	--
Output Power (dBm)	--	--
Attainable Rate (Kbps)	--	--
Rate (kbps)	--	--
K (number of bytes in DMT frame)	--	--
R (number of check bytes in RS code word)	--	--
S (RS code word size in DMT frame)	--	--
D (interleave depth)	--	--
Delay (msec)	--	--
FEC	--	--
CRC	--	--
Total ES	--	--
Total SES	--	--
Total UAS	--	--
Total LOSS	--	--
Full Init	0	
Failed Full Init	0	
Last Link DS Rate	0	
Last Link US Rate	0	
TX frames	0	
RX frames	0	
Synchronized time (Second)	0	
Synchronized number	0	
Close Window		

The information that is displayed on this screen is not described in this manual. This information is typically used by NETGEAR support.

- Click the **Close Window** button.

The pop-up screen closes.

View Devices Currently on the Network

You can view the active wired and WiFi devices in both the network to which the modem router is connected and the modem router network. If you do not recognize a WiFi device, it might be an intruder.

➤ To display the wired and WiFi devices:

- Launch an Internet browser from a computer or WiFi device that is connected to the network.
- Type **http://www.routerlogin.net** or **http://www.routerlogin.com**.

A login screen displays.

- Enter the user name and password for the modem router.

The user name is **admin**. The default password is **password**. The user name and password are case-sensitive.

- Click the **OK** button.

The BASIC Home screen displays.

- Select **ADVANCED > Administration > Attached Devices**.

The Attached Devices screen displays.

The screenshot shows the 'Attached Devices' page in the router's web interface. The page is divided into two sections: 'Wired Devices' and 'Wireless Devices (Wireless intruders also show up here)'. The 'Wireless Devices' section contains a table with the following data:

#	IP Address	MAC Address	Device Name
1	192.168.1.2	60:6c:66:da:607d	BusinessLaptop

A 'Refresh' button is located below the table.

Wired devices are connected to the modem router with Ethernet cables. WiFi devices are connected to the modem router through the WiFi network.

The following table describes the fields on the Attached Devices screen.

Field	Description
#	The order in which the device joined the network.
IP Address	The IP address that the modem router assigned to the device when it joined the network. This number can change when a device is disconnected and rejoins the network.
MAC Address	The unique MAC address. The MAC address does not change and is usually shown on the product label.
Device Name	The device name, if detected.

6. To refresh the information onscreen, click the **Refresh** button.
The information onscreen is updated.

7 Troubleshooting

7

This chapter provides information to help you diagnose and solve problems you might experience with your modem router. If you do not find the solution here, check the NETGEAR support site at <http://support.netgear.com> for product and contact information.

This chapter contains the following sections:

- *Quick Tips for Troubleshooting*
- *Troubleshoot with the LEDs*
- *You Cannot Log In to the Modem Router*
- *Troubleshoot the Internet Connection*
- *Changes Are Not Saved*
- *Troubleshoot the WiFi Connectivity*
- *Troubleshoot Your Network Using the Ping Utility*

Quick Tips for Troubleshooting







The following table includes tips for troubleshooting some common problems.

Table 3. Quick tips for troubleshooting

Problem	Possible Solution
Your network is unresponsive or does not function normally.	Restart your network: <ol style="list-style-type: none"> 1. Turn off and unplug the DSL, cable, or fiber modem. 2. Turn off the modem router. 3. Plug in the DSL, cable, or fiber modem and turn it on. Wait two minutes. 4. Turn on the modem router and wait two minutes. If network problems still occur, make sure that your ISP does not require you to use the MAC address of the computer that was used to initially register the ISP account. If your ISP does require that you do this, you must change the router MAC address that the modem router uses. For more information, see Manually Set Up the Internet Connection on page 29.
Your cannot connect over an Ethernet cable to the modem router.	<ul style="list-style-type: none"> • Make sure that the Ethernet cables are securely plugged in. • Make sure that your computer or device does not use a static IP address but is configured to receive an IP address automatically with DHCP. (For most devices, DHCP is the default setting.)
You cannot connect over WiFi to the modem router.	<ul style="list-style-type: none"> • Make sure that the WiFi settings in your WiFi device and modem router match exactly. <p>For a device that is connected over WiFi, the WiFi network name (SSID) and WiFi security settings of the modem router and WiFi computer must match exactly. The default SSID and password are on the product label (see Bottom Panel Product Label on page 10).</p> • Make sure that your WiFi device supports the security that you are using for your WiFi network (WEP, WPA, or WPA2). For information about WiFi security settings, see Manage the Basic WiFi Settings and WiFi Security on page 49. • Make sure that the modem router is not too far from your WiFi device or too close: <ul style="list-style-type: none"> - Move your WiFi device near the modem router but at least 6 feet (2 meters) away and see if the signal strength improves. - Make sure that the WiFi signal is not blocked by objects between the modem router and your WiFi device. • Make sure that the WiFi LED on the modem router is not off. <p>If this LED is off, the WiFi radio might be disabled. For more information about the WiFi radio, see Manage the WiFi Radio on page 56.</p> • Make sure that the modem router's SSID broadcast is not disabled. <p>If the modem router's SSID broadcast is disabled, the WiFi network name is hidden and does not display in your WiFi device's scanning list. To connect to a hidden network, you must type the network name and the WiFi password. For more information about the SSID broadcast, see Manage the Basic WiFi Settings and WiFi Security on page 49.</p> • Make sure that your WiFi device does not use a static IP address but is configured to receive an IP address automatically with DHCP. (For most devices, DHCP is the default setting.)

Troubleshoot with the LEDs

When you turn on the power, the LEDs light as described here.

1. When power is first applied, the Internet LED  lights solid green for about 5 seconds and then turns off.
2. For about 6 seconds, no LEDs light.
3. Both LAN LEDs (1 and 2)  light for about 1 second.
4. After approximately 17 seconds after turning on the power, the following occurs:
 - The WiFi LED  lights green.
 - The LAN port LEDs (1, 2, or both)  light green for any local ports that are connected.
 - The DSL LED  blinks green to indicate that the modem router negotiates the best possible speed on the DSL line. If the negotiation completes and a DSL link is established, the LED turns solid green. If you do not use a DSL modem but a cable or fiber modem, the LED remains blinking.
 - The Power LED  lights solid green.
 - The Internet LED  lights solid green if an Internet connection is established.

Power LED Is Off

If the Power LED  and other LEDs are off when your modem router is turned on, do the following:

- Check that the **Power On/Off** button on the back is in the on position, that is, it is pushed in.
- Check that the power cord is correctly connected to your modem router and that the power supply adapter is correctly connected to a functioning power outlet.
- Check that you are using the 12 VDC 0.5A power adapter that NETGEAR supplied for this product.

If the error persists, a hardware problem might exist. For recovery instructions or help with a hardware problem, contact technical support at www.netgear.com/support.

WiFi LED Is Off

If the WiFi LED  stays off, check to see if the radio on the modem router is turned off (see [Manage the WiFi Radio](#) on page 56). By default, the radio is turned on and the WiFi LED lights solid green.

LAN LED Is Off

If the LAN LED  for a port does not light when you connect a device, check the following:

- The Ethernet cable connections are secure at the modem router and at the hub or device.
- The power is turned on to the connected hub or device.
- You are using the correct cable.

You Cannot Log In to the Modem Router

If you are unable to log in to the modem router from a computer on your local network and use the web management interface, check the following:

- If you are using an Ethernet-connected computer, check the Ethernet connection between the computer and the modem router.
- Make sure that the IP address of your computer is on the same subnet as the modem router. If you are using the recommended addressing scheme, your computer's address is in the range of 192.168.1.2 to 192.168.1.254.
- If your computer's IP address is shown as 169.254.x.x, recent versions of Windows and Mac OS generate and assign an IP address if the computer cannot reach a DHCP server. These autogenerated addresses are in the range of 169.254.x.x. If your IP address is in this range, check the connection from the computer to the modem router and reboot your computer.
- If your modem router's IP address was changed and you do not know the current IP address, use an IP scanner application to detect the IP address. If you still cannot find the IP address, clear the modem router's configuration to factory defaults. This sets the modem router's IP address to 192.168.0.1. For more information, see [Return the Modem Router to Its Factory Default Settings](#) on page 87 and [Factory Settings](#) on page 112.
- Make sure that Java, JavaScript, or ActiveX is enabled in your browser. If you are using Internet Explorer, click the **Refresh** button to be sure that the Java applet is loaded.
- Try quitting the browser and launching it again.
- Make sure that you are using the correct login information. The user name is **admin**, and the default password is **password**. Make sure that Caps Lock is off when you enter this information.
- If you are attempting to set up your modem router behind an existing router in your network, set up the modem router as a wireless repeater (see [Set Up the Modem Router as a Wireless Repeater](#) on page 59).
- If you are attempting to set up your modem router as a replacement for an ADSL gateway in your network, the modem router cannot perform many gateway services. For example, the modem router cannot convert ADSL or cable data into Ethernet networking information. NETGEAR does not support such a configuration.

Troubleshoot the Internet Connection

If your modem router cannot access the Internet, check the DSL connection, then the WAN TCP/IP connection.

Troubleshoot the DSL Link

If your modem router is unable to access the Internet, first determine whether the DSL link with the service provider is working. The DSL LED  indicates the state of this connection.

DSL LED Is Green

If the DSL link LED is green, the ADSL connection is good. You can be confident that the service provider connected your line correctly and that your wiring is correct.



DSL LED Is Blinking Green

If the DSL LED is blinking green, your modem router is attempting to make an ADSL connection with the service provider. The DSL LED turns green within several minutes.

If the DSL LED does not turn green, disconnect all telephones on the line. If this solves the problem, reconnect the telephones one at a time, being sure to use a microfilter on each telephone. If the microfilters are connected correctly, you can connect all your telephones.

If disconnecting telephones does not result in a green DSL LED, a problem with your wiring might exist. If the telephone company tested the ADSL signal at your network interface device (NID), then wiring in your house might be of poor quality.

DSL LED Is Off or Internet LED is Off

If the DSL LED  is off, the Internet LED  is off, or both are off, disconnect all telephones on the line. If this solves the problem, reconnect the telephones one at a time, being sure to use a microfilter on each telephone. If the microfilters are connected correctly, you can connect all your telephones.

If disconnecting telephones does not result in a green DSL LED, check the following:

- Check that the telephone company made the connection to your line and tested it.
- Verify that you are connected to the correct telephone line. If more than one phone line is installed, be sure that you are connected to the line with the ADSL service. It might be necessary to use a swapper if your ADSL signal is on pins 1 and 4 or the RJ-11 jack. The modem router uses pins 2 and 3.

Internet LED Is Off

If the Internet LED  is off, the modem router cannot connect to the Internet. Verify the following:

- Check that your login credentials are correct or that the information you entered for the ISP connection is correct (see *Manually Set Up the Internet Connection* on page 29).
- Check if your ISP is experiencing a problem—it might not be that the modem router cannot connect to the Internet, but rather that your ISP cannot provide an Internet connection.

Obtain an Internet IP Address

If the modem router cannot access the Internet and the Internet LED  is green, see if the modem router can obtain an Internet IP address from the ISP. Unless the modem router is assigned a static IP address, the modem router requests an IP address from the ISP. You can determine whether the request was successful using the web management interface.

➤ To check the Internet IP address:

1. Launch an Internet browser from a computer or WiFi device that is connected to the network.
2. Type **http://www.routerlogin.net** or **http://www.routerlogin.com**.
A login screen displays.
3. Enter the user name and password for the modem router.
The user name is **admin**. The default password is **password**. The user name and password are case-sensitive.
4. Click the **OK** button.
The BASIC Home screen displays.
5. Select **ADVANCED > ADVANCED Home**.
The ADVANCED Home screen displays.
6. In the Internet Port pane, check that the **IP Address** field shows a valid IP address.
If the field shows 0.0.0.0, your modem router did not obtain an IP address from your ISP.

If your modem router cannot obtain an IP address from the ISP, the problem might be one of the following:

- Your Internet service provider (ISP) might require a login program.
Ask your ISP whether they require PPP over Ethernet (PPPoE) or some other type of login.
- If you selected a login program, the service name, user name, or password might be incorrectly set.
For more information, see *Troubleshoot PPPoE or PPPoA* on page 106.

- Your ISP might check for your computer's host name. Assign the computer host name of your ISP account as the account name. For more information, see *Manually Set Up the Internet Connection* on page 29.
- If your ISP allows only one Ethernet MAC address to connect to Internet and checks for your computer's MAC address, do one of the following:
 - Inform your ISP that you bought a new network device and ask them to use the modem router's MAC address.
 - Configure your modem router to clone your computer's MAC address. For more information, see *Manually Set Up the Internet Connection* on page 29.

Troubleshoot PPPoE or PPPoA

If you use a PPPoE or PPPoA connection to your ISP, make sure that the connection works.

➤ To verify that your PPPoE or PPPoA connection is working:

1. Launch an Internet browser from a computer or WiFi device that is connected to the network.
2. Type **http://www.routerlogin.net** or **http://www.routerlogin.com**.
A login screen displays.
3. Enter the user name and password for the modem router.
The user name is **admin**. The default password is **password**. The user name and password are case-sensitive.
4. Click the **OK** button.
The BASIC Home screen displays.
5. Select **ADVANCED > ADVANCED Home**.
The ADVANCED Home screen displays.
6. In the Internet Port pane, check that the **IP Address** field shows a valid IP address and that the **Connection** field shows PPPoE or PPPoA.
7. In the Internet Port pane, click the **Connection Status** button.
The Connection Status screen displays.
8. Check the following:
 - The **Connection Status** field shows Connected.
 - The **Connection Time** field does not show 00:00:00.

If all of the information is correct, your PPPoE or PPPoA connection is working.

➤ If your PPPoE or PPPoA connection does not function, attempt to reconnect:

1. Launch an Internet browser from a computer or WiFi device that is connected to the network.
2. Type **http://www.routerlogin.net** or **http://www.routerlogin.com**.

A login screen displays.

3. Enter the user name and password for the modem router.

The user name is **admin**. The default password is **password**. The user name and password are case-sensitive.

4. Click the **OK** button.

The BASIC Home screen displays.

5. Select **ADVANCED > ADVANCED Home**.

The ADVANCED Home screen displays.

6. In the Internet Port pane, click the **Connection Status** button.

The Connection Status screen displays.

7. Click the **Connect** button.

The modem router attempts to reconnect.

If you cannot connect after several minutes, you might be using an incorrect service name, user name, or password. There might also be a provisioning problem with your ISP.

Unless you connect manually, the modem router does not authenticate using PPPoE or PPPoA until data is transmitted to the network.

Troubleshoot Internet Browsing

If your modem router can obtain an IP address but your computer is unable to load any web pages from the Internet, it might be for one of the following reasons:

- Your computer might not recognize any DNS server addresses.

A DNS server is a host on the Internet that translates Internet names (such as www addresses) to numeric IP addresses. Typically your ISP provides the addresses of one or two DNS servers for your use. If you entered a DNS address when you set up the modem router, reboot your computer and verify the DNS address. Alternatively, you can configure your computer manually with DNS addresses, as explained in your operating system documentation.

- The modem router might not be configured as the TCP/IP router on your computer.

For information about TCP/IP problems, see *Troubleshoot Your Network Using the Ping Utility* on page 109.

If your computer obtains its information from the modem router by DHCP, reboot the computer and verify the modem router address.

Changes Are Not Saved

If the modem router does not save the changes you make in the web management interface, do the following:

- When entering configuration settings, always click the **Apply** button before moving to another screen or tab or your changes are lost.
- Click the **Refresh** or **Reload** button in the web browser. It is possible that the changes occurred, but that the old settings remain in the web browser's cache.

Troubleshoot the WiFi Connectivity

If you are having trouble connecting over WiFi to the modem router, try to isolate the problem:

- Make sure that the WiFi settings in your WiFi device and modem router match exactly.

For a device that is connected over WiFi, the WiFi network name (SSID) and WiFi security settings of the modem router and WiFi computer must match exactly. The default SSID and password are on the product label (see *Bottom Panel Product Label* on page 10).

- Does the WiFi device that you are using find your WiFi network?

If not, check the WiFi LED on the front of the modem router. If this LED is off, the WiFi radio might be disabled. For more information about the WiFi radio, see *Manage the WiFi Radio* on page 56.

- If you disabled the modem router's SSID broadcast, your WiFi network is hidden and does not display in your WiFi client's scanning list. (By default, SSID broadcast is enabled.) For more information, see *Manage the Basic WiFi Settings and WiFi Security* on page 49.
- Does your WiFi device support the security that you are using for your WiFi network (WEP, WPA, or WPA2)? For information about changing the WiFi security, see *Manage the Basic WiFi Settings and WiFi Security* on page 49.

Note: If you want to change the WiFi settings for the modem router, use an Ethernet cable to connect a computer to a LAN port on the modem router and then log in to the modem router.

If your WiFi device finds your network but the signal strength is weak, check these conditions:

- Is your modem router too far from your WiFi device or too close? Place your WiFi device near the modem router but at least 6 feet (1.8 meters) away and see whether the signal strength improves.
- Are objects between the modem router and your WiFi device blocking the WiFi signal?

Troubleshoot Your Network Using the Ping Utility

Most network devices and routers contain a ping utility that sends an echo request packet to the designated device. The device then responds with an echo reply. You can easily troubleshoot a network using the ping utility in your computer or workstation.

Test the LAN Path to Your Modem Router

You can ping the modem router from your computer to verify that the LAN path to your modem router is set up correctly.

➤ **To ping the modem router from a Windows computer:**

1. From the Windows taskbar, click the **Start** button and select **Run**.
2. In the field provided, type **ping** followed by the IP address of the modem router, as in this example:

ping 192.168.0.1

3. Click the **OK** button.

A message such as the following one displays:

```
Pinging <IP address> with 32 bytes of data
```

If the path is working, you see this message:

```
Reply from < IP address >: bytes=32 time=NN ms TTL=xxx
```

If the path is not working, you see this message:

```
Request timed out
```

If the path is not functioning correctly, one of the following problems might be occurring:

- Wrong physical connections

For a wired connection, make sure that the numbered LAN port LED is lit for the port to which you are connected.

Check that the appropriate LEDs are on for your network devices. If your modem router and computer are connected to a separate Ethernet switch, make sure that the link LEDs are lit for the switch ports that are connected to your computer and modem router.

- Wrong network configuration

Verify that the Ethernet card driver software and TCP/IP software are both installed and configured on your computer.

Verify that the IP address for your modem router and your computer are correct and that the addresses are on the same subnet.

Test the Path from Your Computer to a Remote Device

After you verify that the LAN path works correctly, test the path from your computer to a remote device:

1. From the Windows toolbar, click the **Start** button and select **Run**.
2. In the field provided, type

```
ping -n 10 IP address
```

where *IP address* is the IP address of a remote device such as your ISP's DNS server.

If the path is functioning correctly, replies as described in [Test the LAN Path to Your Modem Router](#) on page 109 display. If you do not receive replies, do the following:

- Check that the IP address of your modem router is listed as the default router in your computer. If the IP configuration of your computer is assigned by DHCP, this information is not visible in your computer's Network Control Panel. Verify that the IP address of the modem router is listed as the default router.
- Check that the network address of your computer (the portion of the IP address specified by the netmask) is different from the network address of the remote device.
- If your ISP assigned a host name to your computer, enter that host name as the account name (see [Manually Set Up the Internet Connection](#) on page 29).
- Your ISP might be rejecting the Ethernet MAC addresses of all but one of your computers.

Many broadband ISPs restrict access by allowing traffic only from the MAC address of your modem, but some additionally restrict access to the MAC address of a single computer connected to that modem. In this case, configure your modem router to clone or spoof the MAC address from the authorized computer (see [Manually Set Up the Internet Connection](#) on page 29).

A Supplemental Information

A

This appendix covers the following topics:

- *Factory Settings*
- *Technical and Environmental Specifications*

Factory Settings

You can return the modem router to its factory default settings (see [Return the Modem Router to Its Factory Default Settings](#) on page 87). The following table shows the factory default settings.

Table 4. Factory default settings

Feature		Default Behavior
Router Login	User login URL	www.routerlogin.com or www.routerlogin.net
	User name (case-sensitive)	admin
	Login password (case-sensitive)	password
Internet connection and port configuration	WAN preference setting	Must use DLS WAN
	Use of second Ethernet port	LAN
	Network Address Translation (NAT)	Enabled
	WAN MAC address	Use default hardware address
Local area network (LAN)	LAN IP address	192.168.1.1
	Subnet mask	255.255.255.0
	DHCP server	Enabled
	DHCP range	192.168.1.2 to 192.168.1.254
	DHCP start IP address	192.168.1.2
	DHCP end IP address	192.168.1.254
Wide area network (WAN)	WAN MTU size	1500
	Port scan and DoS protection	Disabled
	Respond to ping on Internet port	Disabled
	IGMP proxying	Disabled
	NAT filtering	Secured
	SIP ALG	Enabled
	FTP ALG	Enabled
	VPN pass-through	Enabled for IPSec, PPTP, and L2TP

Table 4. Factory default settings (continued)

Feature		Default Behavior
WiFi	WiFi radio	Enabled
	SSID name	See router label
	Security	WPA2-PSK (AES) See router label
	Broadcast SSID	Enabled
	Country/region	Varies by region
	RF channel	Auto
	Operating mode ¹	<ul style="list-style-type: none"> N150 WiFi DSL Modem Router Model D500: Up to 150 Mbps at 2.4 GHz N300 WiFi DSL Modem Router Model D1500: Up to 300 Mbps at 2.4 GHz
	Radio transmission power	100 percent
	20/40 MHz coexistence	Enabled
	Fragmentation length	2346
	CTS/RTS threshold	2347
	Preamble mode	Long preamble
Wireless isolation	Disabled	

1. Maximum WiFi signal rate derived from IEEE Standard 802.11 specifications. Actual throughput can vary. Network conditions and environmental factors, including volume of network traffic, building materials and construction, and network overhead, lower actual data throughput rate.

Technical and Environmental Specifications

Table 5. Modem router specifications

Feature	Description
Data and routing protocols	TCP/IP, DHCP, PPPoE, PPTP, IPoA, DNS, and UPnP
Power adapter	<ul style="list-style-type: none"> North America: 120V, 60 Hz, input UK, Australia: 240V, 50 Hz, input Europe: 230V, 50 Hz, input All regions (output): 12V/0.5 ADC output
Dimensions	All models: 166 x 100 x 28 mm (6.5 x 3.9 x 1.1 in.)
Weight	<ul style="list-style-type: none"> N150 WiFi DSL Modem Router Model D500: 131 g (0.29 lb) N300 WiFi DSL Modem Router Model D1500: 141 g (0.31 lb)
Operating temperature	0° to 40°C (32° to 104°F)

Table 5. Modem router specifications (continued)

Feature	Description
Operating humidity	90% maximum relative humidity, noncondensing
Electromagnetic emissions	EN 55 022 (CISPR 22), Class B C-Tick N10947
LAN	10BASE-T or 100BASE-TX, RJ-45
WAN	10BASE-T or 100BASE-TX, RJ-45
WiFi	Maximum WiFi signal rate complies with the IEEE 802.11 standard. ¹
Radio data rates	Auto rate sensing
Data encoding standards	IEEE 802.11n version 2.0 IEEE 802.11n, IEEE 802.11g, and IEEE 802.11b 2.4 GHz
Maximum computers per WiFi network	Limited by the amount of WiFi network traffic generated by each node (typically 16 nodes).
Operating frequency range	2.412–2.462 GHz (US) 2.412–2.472 GHz (Japan) 2.412–2.472 GHz (Europe ETSI)
802.11 security	WEP, WPA-PSK, WPA2-PSK, and WPA/WPA2

1. Maximum WiFi signal rate derived from IEEE Standard 802.11 specifications. Actual throughput can vary. Network conditions and environmental factors, including volume of network traffic, building materials and construction, and network overhead, lower actual data throughput rate.